

ALO

ALO 1

CARATTERISTICHE PRINCIPALI

Applicazioni	Illuminazione grandi aree e impianti sportivi.
Gruppo ottico	AM10 / AN10 / AW10 / ASM / ASN / ASW / A25: Ottica asimmetrica per proiezione. Temperatura di colore: 4000K, CRI ≥ 70 3000K, CRI ≥ 70 in opzione Efficienza sorgente LED: 165 lm/W @ 350mA, Tj=85°C, 4000K
Classe di isolamento	I
Grado di protezione	IP66 IK08 totale
Dimensioni	Vedere disegno
Peso	max 12,5 kg (alimentatore escluso)
Superficie esposta	Laterale: 0,026 m ² – Pianta: 0,15 m ² (alimentatore escluso) SCx: 0.13 m ²
Montaggio	Installazione con staffa C o MICROMOOVER.
Inclinazione	Attacco staffa C: -90° ÷ +90° su piano orizzontale con step graduati a scatti controllati di 5°. Microregolazione con asole ±2,5° (step di 0,5°) per valori intermedi alla regolazione principale. MICROMOOVER: +20° ÷ +75° su piano orizzontale. Microregolazione 0/+10° per valori intermedi alla regolazione principale. Regolazione su asse verticale: ±180°.
Cablaggio	Remoto. (Dim. Alimentatore 335x144mm H=60mm – Peso: 3,4 kg). In opzione: montaggio sul corpo apparecchio con staffe integrate (solo versione con staffa C).
Temp. di esercizio	-40°C / +50°C
Temp. di stoccaggio	-40°C / +80°C
Norme di riferimento	EN 60598-1, EN 60598-2-3, EN 60598-2-5, IEC 62471, EN 55015, EN 61547, EN 61000-3-2, EN 61000-3-3



CARATTERISTICHE ELETTRICHE

Alimentazione	220÷480V 50/60Hz (Tolleranza standard ±10%. Altri voltaggi e tolleranze su richiesta)
Fattore di potenza	>0,9 (a pieno carico)
Flicker factor (FF)	< 3%
Connessione rete	Su morsettiera per cavi sezione max. 4mm ²
Protezione alla sovratensione	Fino a 10kV
Sistema di controllo (opzioni)	F: Fisso non dimmerabile. DAC: Dimmerazione automatica (mezzanotte virtuale) con profilo custom. FLC: Flusso luminoso costante. DALI: Interfaccia di dimmerazione digitale DALI.
Vita gruppo ottico (Tq=25°C, 650mA)	>100.000hr L80B10

MATERIALI

Attacco	Acciaio zincato a caldo e verniciato.
Corpo - Dissipatore	Alluminio pressofuso UNI EN1706. Verniciato a polveri.
Telaio portavetro	Acciaio zincato e verniciato con molle in acciaio inox.
Gruppo ottico	Policarbonato
Schermo	Vetro piano temperato sp. 5mm elevata trasparenza.
Pressacavo	Metallico M20 x 1,5 - IP68
Guarnizione	Siliconica
Colore	Grigio opaco satinato RAL 7004 - Cod. 7J

ACCESSORI

ES	External Shield - Schermo anti inquinamento luminoso.
Supporto alimentatore	Supporto per montaggio alimentatore integrato su proiettore (solo versione con staffa C).

GREENLIGHT



DISEGNI DIMENSIONALI

ALO con staffa C

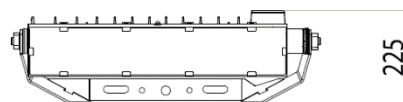
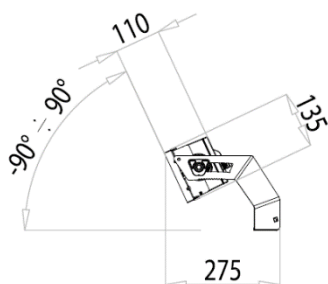
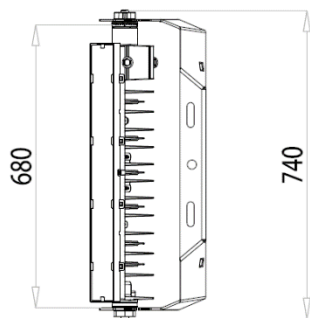

ALO con MICROMOOVER

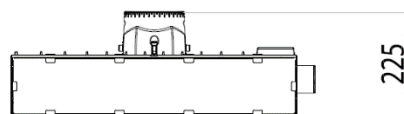
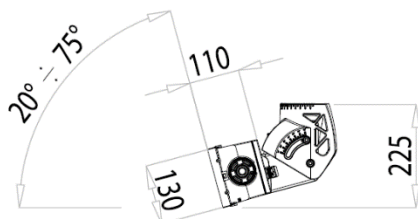
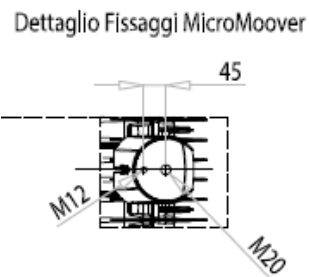
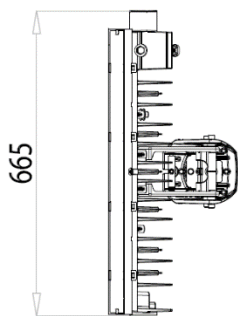

ALO 1 2AB10 WIDE AREA – 7040

APPARECCHIO	OTTICA	CORRENTE LED (mA)	FLUSSO APPARECCHIO* (Tq=25°C, 4000K, lm)	POTENZA APPARECCHIO* (Tq=25°C, Vin=230Vac, F, W)	EFFICIENZA APPARECCHIO (Tq=25°C, lm/W)	FLUSSO NOMINALE LED* (Tj=85°C, 4000K, lm)	POTENZA NOMINALE LED* (Tj=85°C, W)
ALO 1 2AB10 A25 7040.350-22M	A25	350	32950	225	146.4	37700	210
ALO 1 2AB10 A25 7040.400-22M	A25	400	37000	260	142.3	42700	245
ALO 1 2AB10 A25 7040.450-22M	A25	450	40950	290	141.2	47600	275
ALO 1 2AB10 A25 7040.500-22M	A25	500	44700	325	137.5	52400	310
ALO 1 2AB10 A25 7040.550-22M	A25	550	48300	360	134.1	57100	345
ALO 1 2AB10 A25 7040.600-22M	A25	600	51800	395	131.1	61700	380
ALO 1 2AB10 A25 7040.650-22M	A25	650	55150	430	128.2	66200	415
ALO 1 2AB10 A25 7040.700-22M	A25	700	58400	465	125.5	70700	450
ALO 1 2AB10 A25 7040.350-22M ES	A25	350	31630	225	140.5	37700	210
ALO 1 2AB10 A25 7040.400-22M ES	A25	400	35520	260	136.6	42700	245
ALO 1 2AB10 A25 7040.450-22M ES	A25	450	39310	290	135.5	47600	275
ALO 1 2AB10 A25 7040.500-22M ES	A25	500	42910	325	132	52400	310
ALO 1 2AB10 A25 7040.550-22M ES	A25	550	46370	360	128.8	57100	345
ALO 1 2AB10 A25 7040.600-22M ES	A25	600	49730	395	125.8	61700	380
ALO 1 2AB10 A25 7040.650-22M ES	A25	650	52940	430	123.1	66200	415
ALO 1 2AB10 A25 7040.700-22M ES	A25	700	56060	465	120.5	70700	450
ALO 1 2AB10 AM10 7040.350-22M	AM10	350	32600	225	144.8	37700	210
ALO 1 2AB10 AM10 7040.400-22M	AM10	400	36650	260	140.9	42700	245
ALO 1 2AB10 AM10 7040.450-22M	AM10	450	40500	290	139.6	47600	275
ALO 1 2AB10 AM10 7040.500-22M	AM10	500	44250	325	136.1	52400	310
ALO 1 2AB10 AM10 7040.550-22M	AM10	550	47800	360	132.7	57100	345
ALO 1 2AB10 AM10 7040.600-22M	AM10	600	51250	395	129.7	61700	380
ALO 1 2AB10 AM10 7040.650-22M	AM10	650	54600	430	126.9	66200	415
ALO 1 2AB10 AM10 7040.700-22M	AM10	700	57800	465	124.3	70700	450

APPARECCHIO	OTTICA	CORRENTE LED (mA)	FLUSSO APPARECCHIO* (Tq=25°C, 4000K, lm)	POTENZA APPARECCHIO* (Tq=25°C, Vin=230Vac, F, W)	EFFICIENZA APPARECCHIO (Tq=25°C, lm/W)	FLUSSO NOMINALE LED* (Tj=85°C, 4000K, lm)	POTENZA NOMINALE LED* (Tj=85°C, W)
ALO 1 2AB10 AM10 7040.350-22M ES	AM10	350	29340	225	130.4	37700	210
ALO 1 2AB10 AM10 7040.400-22M ES	AM10	400	32990	260	126.8	42700	245
ALO 1 2AB10 AM10 7040.450-22M ES	AM10	450	36450	290	125.6	47600	275
ALO 1 2AB10 AM10 7040.500-22M ES	AM10	500	39830	325	122.5	52400	310
ALO 1 2AB10 AM10 7040.550-22M ES	AM10	550	43020	360	119.5	57100	345
ALO 1 2AB10 AM10 7040.600-22M ES	AM10	600	46130	395	116.7	61700	380
ALO 1 2AB10 AM10 7040.650-22M ES	AM10	650	49140	430	114.2	66200	415
ALO 1 2AB10 AM10 7040.700-22M ES	AM10	700	52020	465	111.8	70700	450
ALO 1 2AB10 AN10 7040.350-22M	AN10	350	33100	225	147.1	37700	210
ALO 1 2AB10 AN10 7040.400-22M	AN10	400	37150	260	142.8	42700	245
ALO 1 2AB10 AN10 7040.450-22M	AN10	450	41100	290	141.7	47600	275
ALO 1 2AB10 AN10 7040.500-22M	AN10	500	44900	325	138.1	52400	310
ALO 1 2AB10 AN10 7040.550-22M	AN10	550	48500	360	134.7	57100	345
ALO 1 2AB10 AN10 7040.600-22M	AN10	600	52000	395	131.6	61700	380
ALO 1 2AB10 AN10 7040.650-22M	AN10	650	55400	430	128.8	66200	415
ALO 1 2AB10 AN10 7040.700-22M	AN10	700	58650	465	126.1	70700	450
ALO 1 2AB10 AN10 7040.350-22M ES	AN10	350	30450	225	135.3	37700	210
ALO 1 2AB10 AN10 7040.400-22M ES	AN10	400	34180	260	131.4	42700	245
ALO 1 2AB10 AN10 7040.450-22M ES	AN10	450	37810	290	130.3	47600	275
ALO 1 2AB10 AN10 7040.500-22M ES	AN10	500	41310	325	127.1	52400	310
ALO 1 2AB10 AN10 7040.550-22M ES	AN10	550	44620	360	123.9	57100	345
ALO 1 2AB10 AN10 7040.600-22M ES	AN10	600	47840	395	121.1	61700	380
ALO 1 2AB10 AN10 7040.650-22M ES	AN10	650	50970	430	118.5	66200	415
ALO 1 2AB10 AN10 7040.700-22M ES	AN10	700	53960	465	116	70700	450
ALO 1 2AB10 ASM 7040.350-22M	ASM	350	33250	225	147.7	37700	210

APPARECCHIO	OTTICA	CORRENTE LED (mA)	FLUSSO APPARECCHIO* (Tq=25°C, 4000K, lm)	POTENZA APPARECCHIO* (Tq=25°C, Vin=230Vac, F, W)	EFFICIENZA APPARECCHIO (Tq=25°C, lm/W)	FLUSSO NOMINALE LED* (Tj=85°C, 4000K, lm)	POTENZA NOMINALE LED* (Tj=85°C, W)
ALO 1 2AB10 ASM 7040.400-22M	ASM	400	37350	260	143.6	42700	245
ALO 1 2AB10 ASM 7040.450-22M	ASM	450	41300	290	142.4	47600	275
ALO 1 2AB10 ASM 7040.500-22M	ASM	500	45100	325	138.7	52400	310
ALO 1 2AB10 ASM 7040.550-22M	ASM	550	48750	360	135.4	57100	345
ALO 1 2AB10 ASM 7040.600-22M	ASM	600	52250	395	132.2	61700	380
ALO 1 2AB10 ASM 7040.650-22M	ASM	650	55650	430	129.4	66200	415
ALO 1 2AB10 ASM 7040.700-22M	ASM	700	58900	465	126.6	70700	450
ALO 1 2AB10 ASM 7040.350-22M ES	ASM	350	31260	225	138.9	37700	210
ALO 1 2AB10 ASM 7040.400-22M ES	ASM	400	35110	260	135	42700	245
ALO 1 2AB10 ASM 7040.450-22M ES	ASM	450	38820	290	133.8	47600	275
ALO 1 2AB10 ASM 7040.500-22M ES	ASM	500	42390	325	130.4	52400	310
ALO 1 2AB10 ASM 7040.550-22M ES	ASM	550	45830	360	127.3	57100	345
ALO 1 2AB10 ASM 7040.600-22M ES	ASM	600	49120	395	124.3	61700	380
ALO 1 2AB10 ASM 7040.650-22M ES	ASM	650	52310	430	121.6	66200	415
ALO 1 2AB10 ASM 7040.700-22M ES	ASM	700	55370	465	119	70700	450
ALO 1 2AB10 ASN 7040.350-22M	ASN	350	32800	225	145.7	37700	210
ALO 1 2AB10 ASN 7040.400-22M	ASN	400	36850	260	141.7	42700	245
ALO 1 2AB10 ASN 7040.450-22M	ASN	450	40750	290	140.5	47600	275
ALO 1 2AB10 ASN 7040.500-22M	ASN	500	44500	325	136.9	52400	310
ALO 1 2AB10 ASN 7040.550-22M	ASN	550	48100	360	133.6	57100	345
ALO 1 2AB10 ASN 7040.600-22M	ASN	600	51550	395	130.5	61700	380
ALO 1 2AB10 ASN 7040.650-22M	ASN	650	54900	430	127.6	66200	415
ALO 1 2AB10 ASN 7040.700-22M	ASN	700	58100	465	124.9	70700	450
ALO 1 2AB10 ASN 7040.350-22M ES	ASN	350	31160	225	138.4	37700	210
ALO 1 2AB10 ASN 7040.400-22M ES	ASN	400	35010	260	134.6	42700	245

APPARECCHIO	OTTICA	CORRENTE LED (mA)	FLUSSO APPARECCHIO* (Tq=25°C, 4000K, lm)	POTENZA APPARECCHIO* (Tq=25°C, Vin=230Vac, F, W)	EFFICIENZA APPARECCHIO (Tq=25°C, lm/W)	FLUSSO NOMINALE LED* (Tj=85°C, 4000K, lm)	POTENZA NOMINALE LED* (Tj=85°C, W)
ALO 1 2AB10 ASN 7040.450-22M ES	ASN	450	38710	290	133.4	47600	275
ALO 1 2AB10 ASN 7040.500-22M ES	ASN	500	42280	325	130	52400	310
ALO 1 2AB10 ASN 7040.550-22M ES	ASN	550	45700	360	126.9	57100	345
ALO 1 2AB10 ASN 7040.600-22M ES	ASN	600	48970	395	123.9	61700	380
ALO 1 2AB10 ASN 7040.650-22M ES	ASN	650	52160	430	121.3	66200	415
ALO 1 2AB10 ASN 7040.700-22M ES	ASN	700	55200	465	118.7	70700	450
ALO 1 2AB10 ASW 7040.350-22M	ASW	350	32750	225	145.5	37700	210
ALO 1 2AB10 ASW 7040.400-22M	ASW	400	36750	260	141.3	42700	245
ALO 1 2AB10 ASW 7040.450-22M	ASW	450	40650	290	140.1	47600	275
ALO 1 2AB10 ASW 7040.500-22M	ASW	500	44400	325	136.6	52400	310
ALO 1 2AB10 ASW 7040.550-22M	ASW	550	48000	360	133.3	57100	345
ALO 1 2AB10 ASW 7040.600-22M	ASW	600	51450	395	130.2	61700	380
ALO 1 2AB10 ASW 7040.650-22M	ASW	650	54750	430	127.3	66200	415
ALO 1 2AB10 ASW 7040.700-22M	ASW	700	57950	465	124.6	70700	450
ALO 1 2AB10 ASW 7040.350-22M ES	ASW	350	31110	225	138.2	37700	210
ALO 1 2AB10 ASW 7040.400-22M ES	ASW	400	34910	260	134.2	42700	245
ALO 1 2AB10 ASW 7040.450-22M ES	ASW	450	38620	290	133.1	47600	275
ALO 1 2AB10 ASW 7040.500-22M ES	ASW	500	42180	325	129.7	52400	310
ALO 1 2AB10 ASW 7040.550-22M ES	ASW	550	45600	360	126.6	57100	345
ALO 1 2AB10 ASW 7040.600-22M ES	ASW	600	48880	395	123.7	61700	380
ALO 1 2AB10 ASW 7040.650-22M ES	ASW	650	52010	430	120.9	66200	415
ALO 1 2AB10 ASW 7040.700-22M ES	ASW	700	55050	465	118.3	70700	450
ALO 1 2AB10 AW10 7040.350-22M	AW10	350	32800	225	145.7	37700	210
ALO 1 2AB10 AW10 7040.400-22M	AW10	400	36800	260	141.5	42700	245
ALO 1 2AB10 AW10 7040.450-22M	AW10	450	40700	290	140.3	47600	275

APPARECCHIO	OTTICA	CORRENTE LED (mA)	FLUSSO APPARECCHIO* (Tq=25°C, 4000K, lm)	POTENZA APPARECCHIO* (Tq=25°C, Vin=230Vac, F, W)	EFFICIENZA APPARECCHIO (Tq=25°C, lm/W)	FLUSSO NOMINALE LED* (Tj=85°C, 4000K, lm)	POTENZA NOMINALE LED* (Tj=85°C, W)
ALO 1 2AB10 AW10 7040.500-22M	AW10	500	44450	325	136.7	52400	310
ALO 1 2AB10 AW10 7040.550-22M	AW10	550	48050	360	133.4	57100	345
ALO 1 2AB10 AW10 7040.600-22M	AW10	600	51500	395	130.3	61700	380
ALO 1 2AB10 AW10 7040.650-22M	AW10	650	54850	430	127.5	66200	415
ALO 1 2AB10 AW10 7040.700-22M	AW10	700	58050	465	124.8	70700	450
ALO 1 2AB10 AW10 7040.350-22M ES	AW10	350	29850	225	132.6	37700	210
ALO 1 2AB10 AW10 7040.400-22M ES	AW10	400	33490	260	128.8	42700	245
ALO 1 2AB10 AW10 7040.450-22M ES	AW10	450	37040	290	127.7	47600	275
ALO 1 2AB10 AW10 7040.500-22M ES	AW10	500	40450	325	124.4	52400	310
ALO 1 2AB10 AW10 7040.550-22M ES	AW10	550	43730	360	121.4	57100	345
ALO 1 2AB10 AW10 7040.600-22M ES	AW10	600	46870	395	118.6	61700	380
ALO 1 2AB10 AW10 7040.650-22M ES	AW10	650	49910	430	116	66200	415
ALO 1 2AB10 AW10 7040.700-22M ES	AW10	700	52830	465	113.6	70700	450

*FLUSSO APPARECCHIO / POTENZA APPARECCHIO: Dati nominali rilevati in laboratorio.

*FLUSSO NOMINALE LED / POTENZA NOMINALE LED: Dati nominali estrapolati da datasheet costruttore LED.

I valori indicati in questa scheda tecnica sono da considerarsi valori nominali. Tolleranza su flusso: $\pm 7\%$. Tolleranza su potenza: $\pm 10\%$.

Al fine di favorire un costante aggiornamento dei propri prodotti, AEC si riserva il diritto di apportare modifiche senza preavviso.

Dati di performance per altre temperature operative (OT) e altre combinazioni di CRI e CCT disponibili su richiesta.

Possono essere previste delle limitazioni in corrente in base alla temperatura operativa. Vedere sezione dedicata nelle pagine seguenti.

Temperatura per Area Geografica

Area Geografica	Paese	Ta media nel Mese più Caldo (°C)	OT Suggestita (°C)	Area Geografica	Paese	Ta media nel Mese più Caldo (°C)	OT Suggestita (°C)
America	Argentina	28	30	EU	Austria	26	25
America	Brazil	28	30	EU	Bosnia Herzegovina	34	35
America	Canada	25	25	EU	Denmark	21	20
America	Chile	30	30	EU	Estonia	21	20
America	Colombia	19	20	EU	Finland	20	20
America	Mexico	27	30	EU	France (Lyon)	28	30
America	Perù	27	30	EU	France (Marseille)	30	30
America	USA (Arizona)	40	40	EU	France (Parigi)	25	25
America	USA (New York)	29	30	EU	Germany	25	25
Asia/Oceania	Australia	27	30	EU	Greece	33	35
Asia/Oceania	South Korea	30	30	EU	Ireland	19	20
Asia/Oceania	Philippines	34	35	EU	Iceland	14	15
Asia/Oceania	Hong Kong	32	35	EU	Canary Islands	28	30
Asia/Oceania	India	36	35	EU	Italy	30	30
Asia/Oceania	Malaysia	33	35	EU	Liechtenstein	24	25
Asia/Oceania	New Zealand	23	25	EU	Lithuania	23	25
Asia/Oceania	Pakistan	34	35	EU	Luxembourg	24	25
Asia/Oceania	Russia	24	25	EU	Malta	32	35
Asia/Oceania	Singapore	32	35	EU	Norway	21	20
Asia/Oceania	Taiwan	34	35	EU	Netherlands	20	20
Asia/Oceania	Vietnam	34	35	EU	Poland	24	25
EMEA	Saudi Arabia	43	45	EU	Portugal	29	30
EMEA	Bahrain	39	40	EU	Czech Republic	25	25
EMEA	Egypt	35	35	EU	Romania	30	30
EMEA	Jordan	32	35	EU	Scotland	19	20
EMEA	Israel	30	30	EU	Slovenia	27	30
EMEA	Kuwait	46	50	EU	Spain (Madrid)	33	35
EMEA	Libanon	30	30	EU	Spain (Malaga)	31	30
EMEA	Morocco	27	30	EU	Spain (Barcelona)	32	35
EMEA	Oman	38	40	EU	Sweden (Goteborg)	21	20
EMEA	Qatar	42	45	EU	Sweden (Borlänge)	23	25
EMEA	UAE (Abu Dhabi)	40	40	EU	Switzerland	25	25
				EU	Turkey (Ankara)	31	30
				EU	Ukraine (Kiev)	26	25
				EU	UK	20	20

Corrente massima per Temperatura operativa

WIDE AREA								
Temperatura (°C)	OT15	OT20	OT25	OT30	OT35	OT40	OT45	OT50
Corrente Max. (mA)	700	700	700	700	650	600	550	500