

Pali | Poles

MATERIALI

UNI EN 10025	Prodotti laminati a caldo di acciai per impieghi strutturali.	<i>Hot rolled products for structural steel.</i>
UNI EN 10219	Profilati cavi formati a freddo di acciai non legati e a grano fine per strutture saldate.	<i>Type Cold formed welded structural hollow sections of non-alloy and fine grain steels.</i>
UNI EN 485	Alluminio e leghe di alluminio. Lamiere, nastri e piastre.	<i>Aluminium and aluminium alloys. Sheets, coils, and plates.</i>
UNI EN 573	Alluminio e leghe di alluminio. Composizione chimica e forma dei prodotti semicolorati.	<i>Aluminum and aluminum alloys. Chemical composition and shape of semi-colored products.</i>
UNI EN ISO 1461	Rivestimenti di zincatura per immersione a caldo su prodotti finiti ferrosi e articoli di acciaio. Specificazioni e metodi di prova.	<i>Hot dip galvanized coatings on fabricated iron and steel articles. Specifications and test methods.</i>

MATERIALS

PROGETTAZIONE

UNI EN 40-1	Pali per illuminazione. Termini e definizioni.	<i>Lighting columns. Definitions and terms.</i>
UNI EN 40-2	Pali per illuminazione. Dimensioni e tolleranze.	<i>Lighting columns. General requirements and dimensions.</i>
UNI EN 40-3-1	Pali per illuminazione pubblica. Progettazione e verifica. Specifica dei carichi caratteristici.	<i>Lighting columns. Design and verification. Specification for characteristic loads.</i>
UNI EN 40-3-2	Pali per illuminazione pubblica. Progettazione e verifica. Verifica tramite prova.	<i>Lighting columns. Design and verification. Verification by testing.</i>
UNI EN 40-3-3	Pali per illuminazione pubblica. Progettazione e verifica. Verifica mediante calcolo.	<i>Lighting columns. Design and verification. Verification by calculation.</i>
UNI EN 40-5 ⁽¹⁾	Pali per illuminazione pubblica. Specifiche per pali per illuminazione pubblica di acciaio.	<i>Lighting columns. Requirements for steel lighting columns.</i>
UNI EN 40-6 ⁽¹⁾	Pali per illuminazione pubblica. Requisiti per pali per illuminazione pubblica di alluminio.	<i>Lighting columns. Requirements for aluminium lighting columns.</i>

DESIGN

EN40

La norma Europea EN40 "Pali per illuminazione" è stata introdotta nei paesi della Unione Europea nel 2005. La norma regola e controlla i criteri progettuali fino ai requisiti richiesti nelle varie fasi produttive. La marcatura **CE** diventa quindi garanzia di conformità del prodotto per l'uso dichiarato dal costruttore stesso. È responsabilità del progettista identificare l'area massima di portata del palo e identificarlo in base alla zona di installazione specificata nella seguente tabella "ZONA DI VENTO EN 40-3-1" AEC mette a disposizione attraverso il proprio ufficio tecnico il servizio di verifica strutturale dei pali in base alla composizione dei corpi illuminanti prescelti.

EN40

European standard EN40 "Lighting columns" was introduced in the countries of the European Union in 2005. The standard regulates the design criteria, up to the requirements for the various manufacturing stages. Therefore, the **CE** marking constitutes a guarantee of conformity of the product for the use declared by the manufacturer. The designer is responsible for identifying the maximum load area of the pole, based on the installation zone. Through its technical department, AEC is able to provide a structural assessment of the poles, which takes into account the composition of the lighting bodies selected.

NORMATIVE | STANDARDS

ZONE DI VENTO EN40-3-1

CATEGORIA DEL TERRENO

> categoria di terreno "I"

Costa marina. Costa di lago con lunghezza sopravvento di almeno 5 km. Terreno piano senza ostacoli.

> categoria di terreno "II"

Terreni coltivati cintati da siepi, qualche piccola costruzione agricola, case o alberi.

> categoria di terreno "III"

Aree suburbane o industriali e foreste permanenti.

> categoria di terreno "IV"

Aree urbane in cui almeno il 15 % della superficie è coperto da edifici con altezza media maggiore di 15 m.



zona	regione - provincia	Vref (m/sec)	Quota limite (m)
1	Val D'Aosta, Piemonte, Lombardia, Trentino, Alto Adige, Veneto, Friuli Venezia Giulia eccetto provincia di Trieste	25 (m/sec)	+ 1.000 m
2	Emilia Romagna	25 (m/sec)	+ 750 m
3	Toscana, Marche, Umbria, Lazio, Abruzzo, Molise, Campania, Puglia, Basilicata e Calabria eccetto provincia di Reggio Calabria	27 (m/sec)	+ 500 m
4	Sicilia e provincia di Reggio Calabria	28 (m/sec)	+ 500 m
5	Sardegna a oriente congiungente Capo Teulada e Maddalena	28 (m/sec)	+ 750 m
6	Sardegna a occidente congiungente Capo Teulada e Maddalena	28 (m/sec)	+ 500 m
7	Liguria	29 (m/sec)	+ 1.000 m
8	Provincia di Trieste	31 (m/sec)	+ 1.500 m
9	Isole (eccetto Sicilia e Sardegna) e mare aperto	31 (m/sec)	+ 500 m

	PM	DS	EC	EC-R	PU	PQ	PG	PK	PN	PA	PX	PT	CA	PL	PR	AP	PF	PS	PZ	PE	PH	PB	PI	PIS2	PID2	PV	PO	PD	
ARYA		•			•	•					•	•																	
STORY		•			•	•					•	•																	
COMPASS TP-BR					•	•					•	•					•	•	•				•	•	•	•	•	•	
COMPASS TP	•	•	•	•		•	•	•	•	•	•	•																	
COMPASS TP-UB					•	•					•	•																	
Q-DROME		•			•	•					•	•	•	•	•	•	•	•	•	•	•	•	•	•	•	•	•	•	•
I-TRON ZERO		•			•	•					•	•					•	•	•				•	•	•	•	•	•	•
I-TRON 1		•			•	•					•	•					•	•	•				•	•	•	•	•	•	•
STYLO																	•	•	•				•	•	•	•	•	•	•
ARTELYS 350/460/DECO	BR	BR			BR	BR					BR	BR																	
MOD 2.0 URBAN 200 TP/AC	•		•	•		•	•																						
MOD 2.0 URBAN 250 TP/AC	•		•	•		•	•																						
ITALO 1		•			•	•					•	•				•	•	•	•	•	•	•	•	•	•	•	•	•	•
ITALO 2		•			•	•					•	•				•	•	•	•	•	•	•	•	•	•	•	•	•	•
ITALO 3		•			•	•					•	•				•	•	•	•	•	•	•	•	•	•	•	•	•	•
ARMODUE		•			•	•					•	•				•	•	•	•				•	•	•	•	•	•	•
ECORAYS TP		•			•	•					•	•																	
ECORAYS BR	•		•	•		•		•	•	•	•	•																	
MASTER 3	•	•	•	•	•	•		•	•	•	•	•	•		•														
MASTER 6	•	•	•	•	•	•		•	•	•	•	•	•		•														
ITALO 2 URBAN		•			•	•					•	•				•	•	•	•	•	•	•							•
ITALO 2 URBAN TP		•			•	•					•	•				•	•	•	•	•	•	•							

PALI | POLES

	PM	DS	EC	EC-R	PU	PQ	PG	PK	PN	PA	PX	PT	CA	PL	PR	PD	AP	PF	PS	PZ	PE	PH	PB	PI	PIS2	PID2	PV	PO	REVELAMPE	
LOGIKA 1						BR			BR	BR				•				•												
LOGIKA 2						BR			BR	BR				•				•												
Q3-QUADRO						BR								•	•															
Q5-QUADRO						BR								•	•															
ARMONIA 1			BR	BR					BR	BR																				
ARMONIA 2			BR	BR					BR	BR																				
ARMONIA MINI			BR	BR					BR	BR																				
GOBLET			BR	BR			BR		BR	BR																				
DELOS 1																	BR													
DELOS 2																	BR													
SOLED		•			•	•					•		•																	
REVELAMPE LR55																													•	
REVELAMPE LL35																													•	
ESCAPE																														

BR: Con apposito braccio

10

9

8.5

8

7

6

5

4.5

4

3.5

3

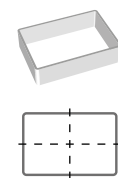

Sezione/Section



Sezione/Section

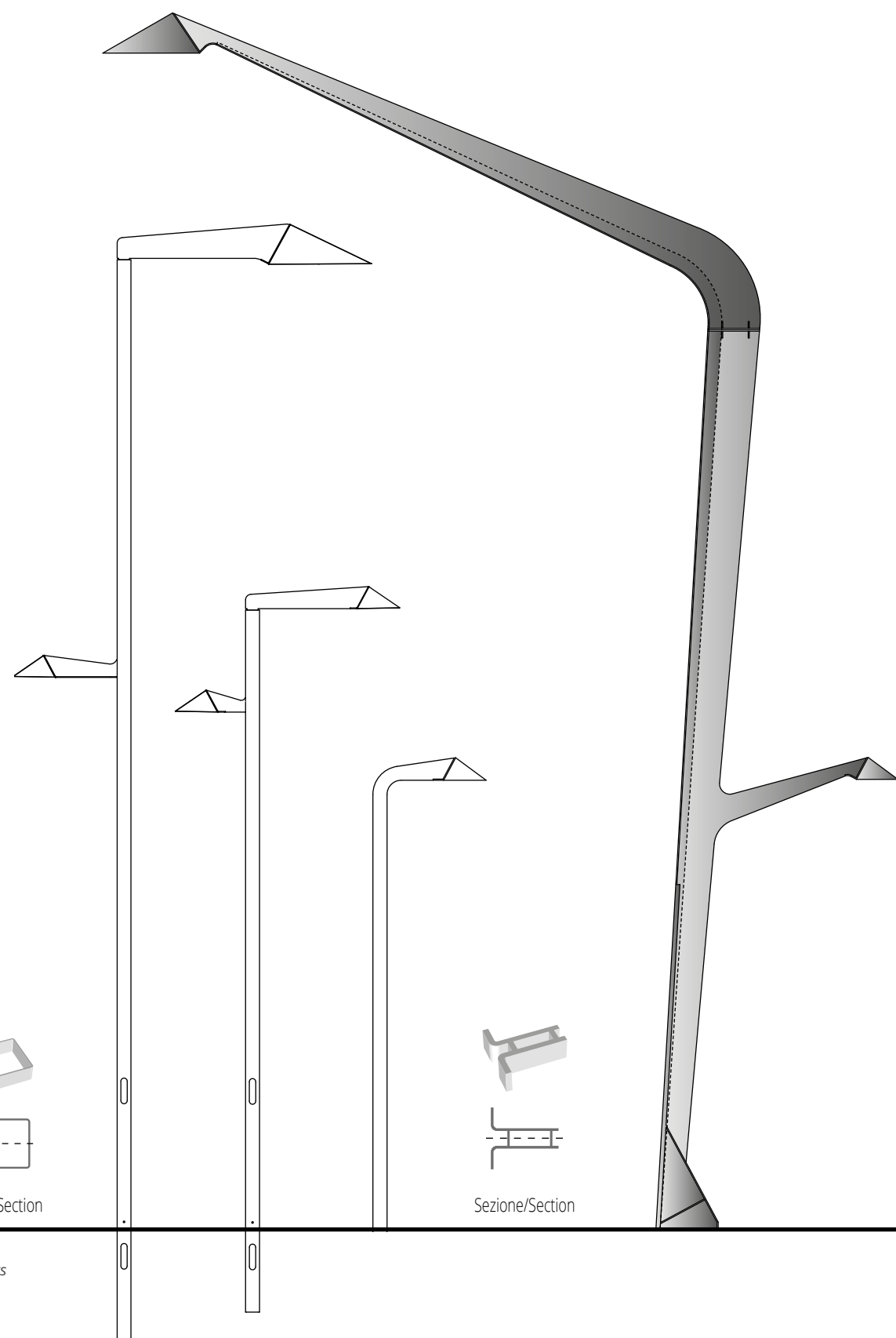

H altezze punto luce
available luminaire heights

ESCAPE

Design series | *Designed by*
Federico Gessi

DESIGN BY FEDERICO GESSI

Il sistema ESCAPE include sostegni per la pubblica illuminazione e complementi d'arredo configurabili sulla base del progetto urbano. Il sistema consiste nella realizzazione di composizioni customizzate, in diverse altezze: combinazioni ad hoc perfettamente contestualizzate nello spazio circostante.

DESIGN BY FEDERICO GESSI

ESCAPE system includes columns and complements for public lighting, freely configurable according to the lighting project. The versatility of the system consists in the realization of customized compositions in different heights: combinations perfectly contextualized in the surrounding space.

Federico Gessi è un giovane artista permeabile a suggestioni ed emozioni. Le sculture che realizza hanno il senso costruttivo che viene dall'autore, dall'essere ingegnere: sono forme geometriche ben incastrate fra loro, ma dalla configurazione tutt'altro che semplice. Forme che si sovrappongono, si intersecano, si amalgamano; si studiano con simpatia o antipatia, si attraggono e si respingono. Forme ottenute con materiali diversi quali legno, metallo, resina. Forme dai colori precisi che esprimono dinamismo, forme emotive: briose e attraenti quelle morbide dei giorni sereni; ispide e "ferrose" quelle delle giornate rese fosche dai problemi. "Sculpture fluide", come fluido è il correre del tempo.

Federico Gessi is a young artist permeable to memories and emotions. The sculptures from him realized come out from the artist background as an engineer: geometric shapes are well stuck together, but by no simple configuration. Forms that overlap, intersect, blend; are studied with sympathy or antipathy, attract and repel. Forms obtained with different materials such as wood, metal, resin. Forms with colors that express dynamism, emotional forms: lively and attractive ones of halcyon days, bristly and "iron" of those days made dismal by the problems. "Fluid sculpture", as fluid is the passage of time.

Franco Panzini



APPLICAZIONI | APPLICATIONS



1



3



2

- 1. Pesaro (Italy)
- 2. Pesaro (Italy)
- 3. Pesaro (Italy)
- 4. Pesaro (Italy)



4

APPLICAZIONI SU PALO APPLICATIONS ON POLES

La riqualificazione della zona mare di Pesaro, è partita dalla Sfera Grande di Arnaldo Pomodoro e ha riguardato Piazza della Libertà e Viale della Repubblica. Per questo progetto il Comune di Pesaro ha scelto AEC Illuminazione, con il sistema ESCAPE disegnato dal Designer Federico Gessi. ESCAPE include sostegni per la pubblica illuminazione e complementi d'arredo configurabili sulla base del progetto urbano. Il sistema consiste nella realizzazione di composizioni customizzate, in diverse altezze da 3,25m - 4,5m e 7m. Un'efficiente soluzione che il comune di Pesaro ha scelto per dare valore allo storico viale di questa splendida cittadina, assicurando ai cittadini e turisti elevato comfort visivo, sostenibilità ambientale e maggiore sicurezza.

The re-styling of Pesaro started from "Sfera Grande" engineered by Arnaldo Pomodoro, and it has included Piazza della Libertà and Viale della Repubblica. For this project, Pesaro Municipality has chosen AEC Illuminazione with ESCAPE System designed by Federico Gessi. ESCAPE System includes columns and complements for public lighting, freely configurable according to the lighting project. The versatility of the system consists in the realization of customized compositions in different heights (from 3,25m - 4,25m and 7m) and combinations perfectly contextualized in the surrounding space. This efficient solution has assured visual comfort, sustainability and more safety for both visitors and tourists.



1. Pesaro (Italy)
2. Pesaro (Italy)

10

9

8

7

6

5

4

3

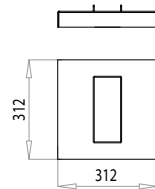
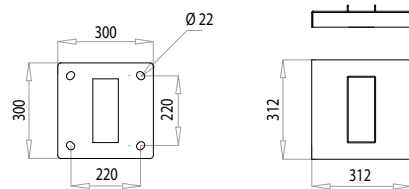
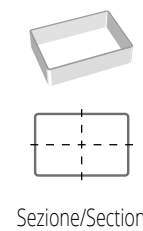
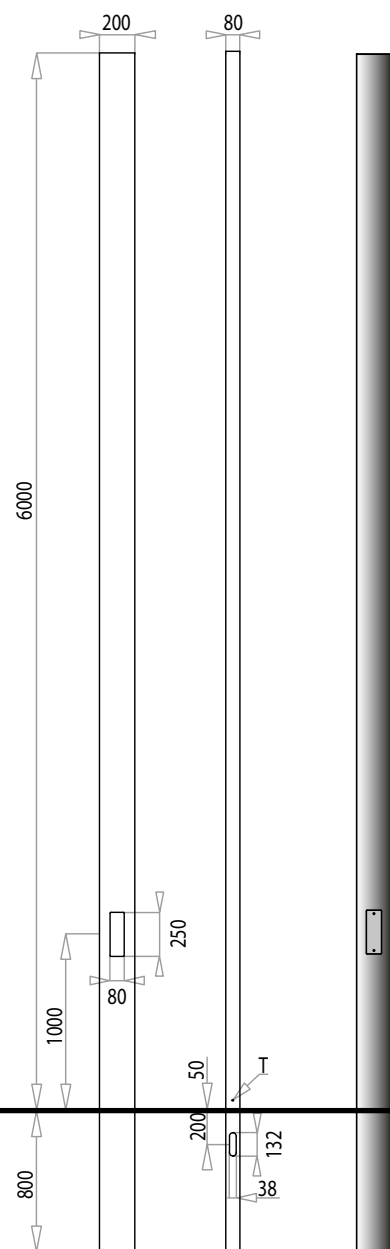

Sezione/Section

H altezze punto luce
available luminaire heights

RX2

MOD 2.0 URBAN 200
Palo rettangolare | Rectangular pole 200x80

Palo in alluminio a sezione rettangolare, realizzato in un unico tratto trafilato*.
I pali della serie RX2 fanno parte dell'apparecchio MOD 2.0 URBAN 200.
Verniciatura a polveri poliestere.
Cod. 01 RAL Standard
Cod. 02, 03, 04 RAL su richiesta.

* La serie RX2 è disponibile anche nella versione in acciaio. Per maggiori informazioni consultare la scheda tecnica (scaricabile dal sito www.aecilluminazione.it) e il listino prezzi.

Rectangular cross section aluminium pole consisting of one single drawn section.
The poles of the RX2 range are part of the luminaire MOD 2.0 URBAN 200. Polyester powder coating.
Cod. 01 RAL Standard
Cod. 02, 03, 04 RAL on request.*

* RX2 series is also available in steel version. For more information please consult the technical data sheet (available on the website www.aecilluminazione.com) and the price list.





ACCESSORI ACCESSORIES

RX2

MOD 2.0 URBAN 200

Palo rettangolare | Rectangular pole 200x80



PORTELLA CON MORSETTIERA TERMINAL BLOCK WITH HATCH

	Standard Standard
RX2 4000	T-39 Q
RX2 5000	T-39 Q
RX2 6000	T-39 Q

Disponibili a 1 o 2 fusibili - Available with 1 or 2 fuses

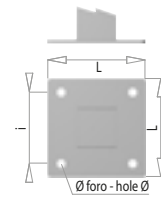

PIASTRA - PLATE

	i	LxL	Ø Foro Hole Ø	Spessore Thickness
RX2 4000	200	300X300	22	15
RX2 5000	200	300X300	22	15
RX2 6000	200	300X300	22	15

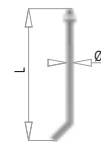

KIT TIRAFONDI - ANCHOR BOLTS

L	500
Ø	M 18

			RX2 4000	RX2 5000	RX2 6000
DIMENSIONI DIMENSIONS	D1	Tratto unico (Ø x spessore) Single section (Ø x thickness)	200x80x6,7 mm	200x80x6,7 mm	200x80x6,7 mm
MATERIALI MATERIALS		Tratto unico Single section	ENAW 6063 T66	ENAW 6063 T66	ENAW 6063 T66
LAVORAZIONI FINISHING	A1	Asola morsettiera Terminal block hole	250x80 mm	250x80 mm	250x80 mm
	A2	Asola ingresso cavi Cable slot	132x38 mm	132x38 mm	132x38 mm
	T	Messa a terra Grounding	Inserito filettato M10, zincato - M10 threaded, galvanized insert		
ALTEZZA HEIGHT	H	Altezza punto luce Luminaire height	4000 mm	5000 mm	6000 mm
	H1	Altezza portella Hatch height	1000 mm	1000 mm	1000 mm
	H2	Asola passaggio cavi Cable slot height	200 mm	200 mm	200 mm
INTERRAMENTO IN-GROUNDING	P		500 mm	500 mm	800 mm
PESO WEIGHT			44 kg	54 kg	67 kg

La scelta del palo è soggetta a verifica strutturale effettuata in base alla zona di installazione. AEC procede al dimensionamento e alla verifica della resistenza del sostegno secondo la normativa EN-40.

The pole must be chosen after a structural pole test depending on the area of installation. AEC verifies the dimensioning and the resistance of the column according to the EN-40 standard.

Valori espressi in millimetri | Measures in millimeters

10

9

8

7

6

5

4

3

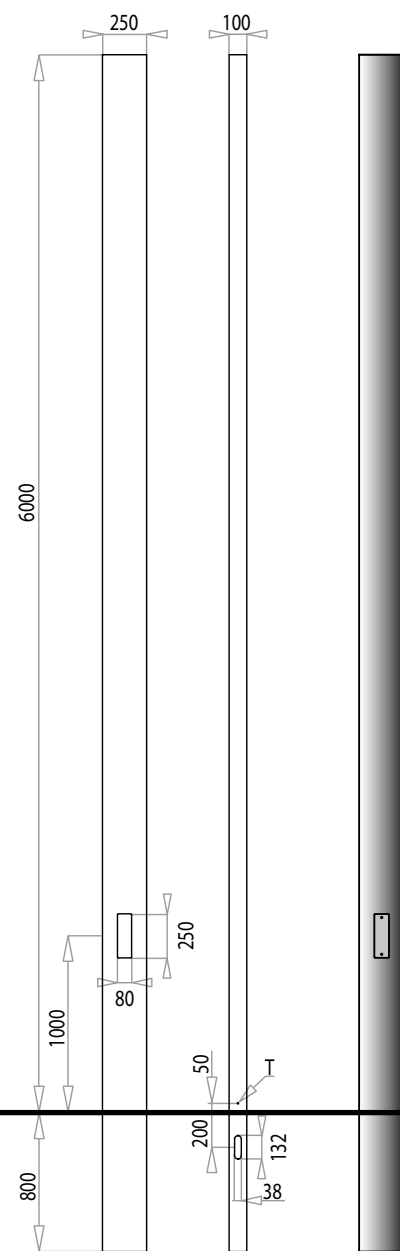

H altezze punto luce
available luminaire heights

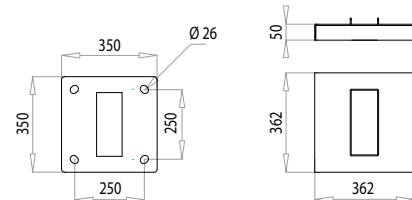

RX3

MOD 2.0 URBAN 250

Palo rettangolare | Rectangular pole 250x100

Palo in alluminio a sezione rettangolare, realizzato in un unico tratto trafilato*.

I pali della serie RX3 fanno parte dell'apparecchio MOD 2.0 URBAN 250.

Verniciatura a polveri poliestere.

Cod. 01 RAL Standard

Cod. 02, 03, 04 RAL su richiesta.

Rectangular cross section aluminium pole consisting of one single drawn section.*

The poles of the RX3 range are part of the luminaire MOD 2.0 URBAN 250. Polyester powder coating.

Cod. 01 RAL Standard

Cod. 02, 03, 04 RAL on request.



ACCESSORI ACCESSORIES



PORTELLA CON MORSETTIERA TERMINAL BLOCK WITH HATCH

	Standard Standard
RX3 4000	MVE/416/00DIN
RX3 5000	MVE/416/00DIN
RX3 6000	MVE/416/00DIN

Disponibili a 1 o 2 fusibili - Available with 1 or 2 fuses

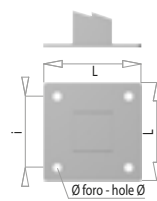

PIASTRA - PLATE

	i	LxL	Ø Foro Hole Ø	Spessore Thickness
RX3 4000	250	350x350	26	20
RX3 5000	250	350x350	26	20
RX3 6000	250	350x350	26	20

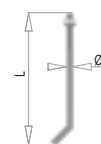

KIT TIRAFONDI - ANCHOR BOLTS

L	500
Ø	M 22

Valori espressi in millimetri | Measures in millimeters

RX3

MOD 2.0 URBAN 250

Palo rettangolare | Rectangular pole 250x100

			RX3 4000	RX3 5000	RX3 6000
DIMENSIONI DIMENSIONS	D1	Tratto unico (Ø x spessore) Single section (Ø x thickness)	250x100x6 mm	250x100x6 mm	250x100x6 mm
MATERIALI MATERIALS		Tratto unico Single section	ENAW 6063 T66	ENAW 6063 T66	ENAW 6063 T66
LAVORAZIONI FINISHING	A1	Asola morsettiere Terminal block hole	250x80 mm	250x80 mm	250x80 mm
	A2	Asola ingresso cavi Cable slot	132x38 mm	132x38 mm	132x38 mm
	T	Messa a terra Grounding	Inserito filettato M10, zincato - M10 threaded, galvanized insert		
ALTEZZA HEIGHT	H	Altezza punto luce Luminaire height	4000 mm	5000 mm	6000 mm
	H1	Altezza portella Hatch height	1000 mm	1000 mm	1000 mm
	H2	Asola passaggio cavi Cable slot height	200 mm	200 mm	200 mm
INTERRAMENTO IN-GROUNDING	P		500 mm	500 mm	800 mm
PESO WEIGHT			54 kg	62 kg	77 kg

La scelta del palo è soggetta a verifica strutturale effettuata in base alla zona di installazione. AEC procede al dimensionamento e alla verifica della resistenza del sostegno secondo la normativa EN-40.

The pole must be chosen after a structural pole test depending on the area of installation. AEC verifies the dimensioning and the resistance of the column according to the EN-40 standard.

10

9

8

7

6

5

4

3

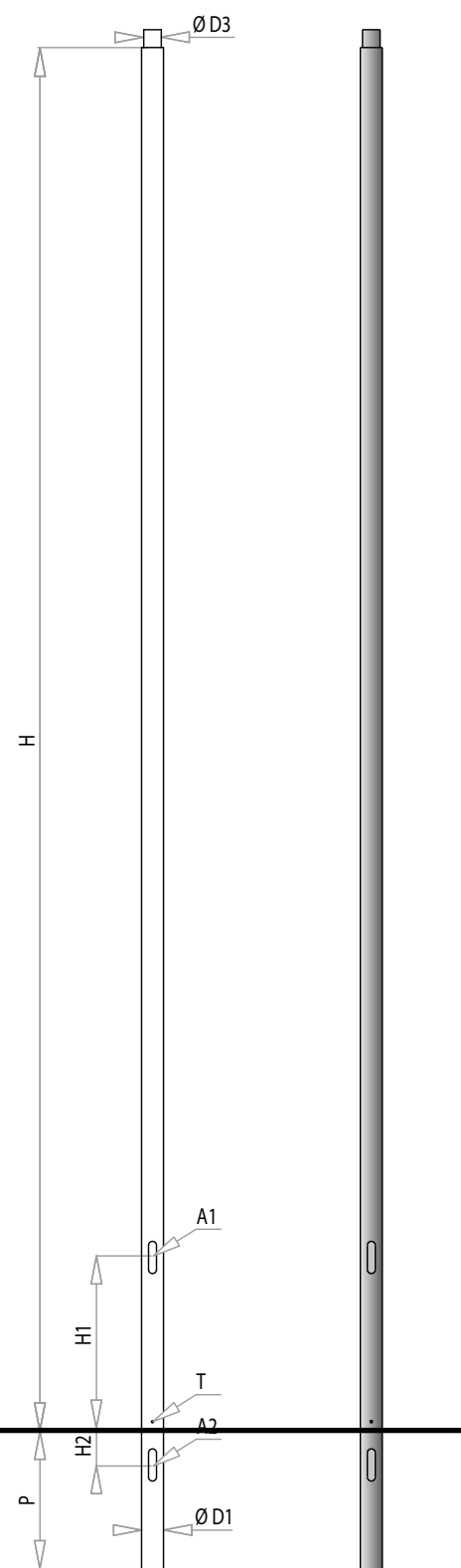

H altezze punto luce
available luminaire heights

ACCESSORI ACCESSORIES

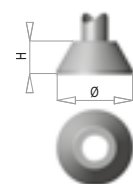

BASE BA/1

	PM 4 - PM 5 - PM 6
H	160
Ø	260



BASE BA/2

	PM 7 - PM 8
H	160
Ø	360

PORTELLA CON MORSETTIERA
TERMINAL BLOCK WITH HATCH

	Standard Standard	Filo palo Flush mounted
PM 4	T-39	RESET 11
PM 5	T-39	RESET 11
PM 6	T-39-G	RESET 16
PM 7	T-39-G	RESET 16
PM 8	T-39-G	RESET 16



Disponibili a 1 o 2 fusibili - Available with 1 or 2 fuses

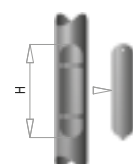

ASOLA MAXI - MAXI TERMINAL BLOCK HOLE

HxL	300x65
-----	--------

Previa verifica strutturale - Structural verification required
Altre su richiesta - Others upon request

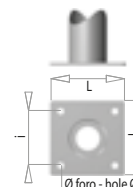

PIASTRA - PLATE

	i	LxL	Ø Foro Hole Ø	Spessore Thickness
PM 4	180	250x250	22	10
PM 5	180	250x250	22	10
PM 6	180	250x250	22	10
PM 7	180	250x250	22	10
PM 8	180	250x250	22	10

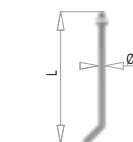

KIT TIRAFONDI - ANCHOR BOLTS

L	500
Ø	M 18

Valori espressi in millimetri | Measures in millimeters

PM

Palo in acciaio a sezione circolare realizzato in un unico tratto. Asola ingresso cavi e asola per morsetti con finitura dei bordi del taglio idonea anche per l'applicazione di portella incassata a filo palo.

Zincatura a caldo secondo la norma ISO 1461 e successiva spazzolatura per garantire una perfetta finitura superficiale. Verniciatura a polveri poliesteri.

Cod. 01,02,03,04, RAL su richiesta.

Circular cross section steel pole consisting of one single section. Cable inlet slot and terminal box slot with finished edges, also suitable for the application of a flush mounted cover door.

Hot galvanized in accordance with ISO 1461, and subsequent brushing to ensure perfect surface finish. Polyester powder coating.

Code 01,02,03,04, RAL on request.

		PM 4	PM 5	PM 6	PM 7	PM 8	
DIMENSIONI DIMENSIONS	D1	Tratto unico (Ø x spessore) Single section (Ø x thickness)	102x3mm	102x3 mm	114x3 mm	127x3 mm	127x3 mm
	D3	Codolo finale Final spigot	60	60	102	102	102
MATERIALE MATERIAL		Tratto unico Single section	S235 JR	S235 JR	S235 JR	S235 JR	S235 JR
LAVORAZIONI FINISHING	A1	Asola morsettiere Terminal block hole	186x45 mm	186x45 mm	186x45 mm	186x45 mm	186x45 mm
	A2	Asola ingresso cavi Cable slot	132x38 mm	132x38 mm	132x38 mm	186x45 mm	186x45 mm
	T	Messa a terra Grounding	Insero filettato M10, zincato - M10 threaded, galvanized insert				
ALTEZZA HEIGHT	H	Altezza punto luce Luminaire height	4000 mm	5000 mm	6000 mm	7000 mm	8000 mm
	H1	Altezza portella Hatch height	1000 mm	1000 mm	1000 mm	1000 mm	1000 mm
	H2	Asola passaggio cavi Cable slot height	200 mm	200 mm	200 mm	200 mm	200 mm
INTERRAMENTO IN-GROUNDING	P		500 mm	500 mm	500 mm	800 mm	800 mm
PESO WEIGHT			33 kg	40 kg	55 kg	73 kg	83 kg

I pali riportati in tabella sono verificati con i seguenti parametri: A: 1 braccio per un apparecchio fino a 25 m/s in categoria II; B: 2 bracci per 2 apparecchi fino a 29 m/s in categoria II. La scelta del palo è soggetta a verifica strutturale effettuata in base alla zona di installazione. AEC procede al dimensionamento e alla verifica della resistenza del sostegno secondo la normativa EN-40.

The poles in the table are verified according to: A: 1 bracket for 1 luminaire up to 25m/s in category II; B: 2 brackets for 2 luminaires up to 29m/s in category II. The pole must be chosen after a structural pole test depending on the area of installation. AEC verifies the dimensioning and the resistance of the column according to the EN-40 standard.

10

9

8

7

6

5

4

3,5

3

Valori espressi in metri | Measures in metres

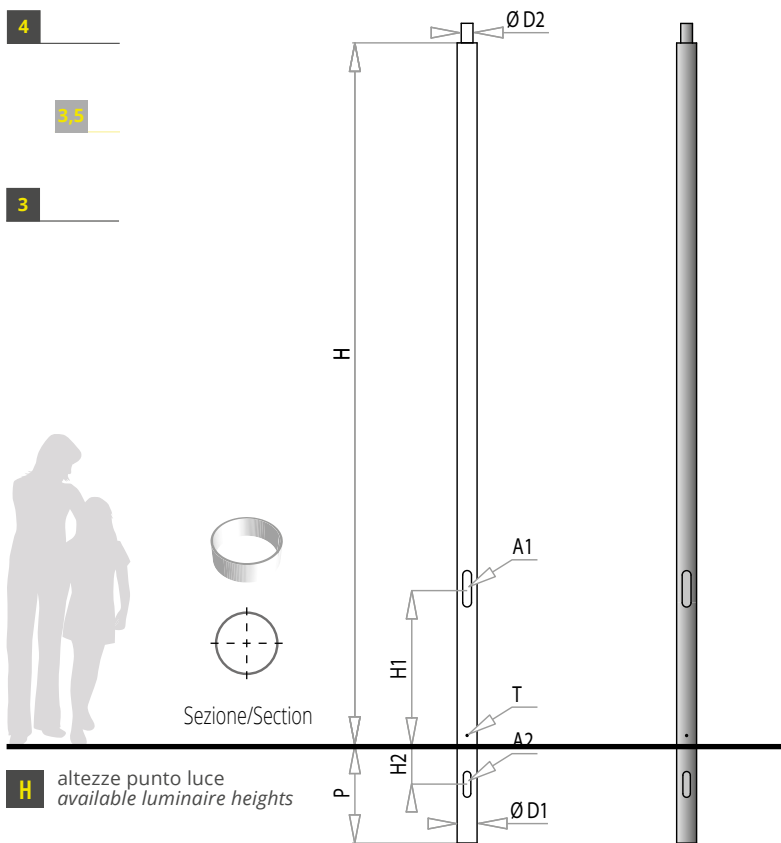

H altezze punto luce
available luminaire heights

ACCESSORI ACCESSORIES

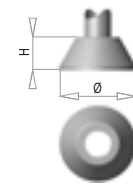

BASE BA/1

H	160
Ø	260

T-39



PORTELLA CON MORSETTIERA
TERMINAL BLOCK WITH HATCH

	Standard Standard	Filo palo Flush mounted
DS 3	T-39	RESET 11
DS 3,5	T-39	RESET 11
DS 4	T-39	RESET 11

RESET



* Disponibili a 1 o 2 fusibili - Available with 1 or 2 fuses

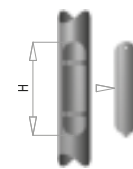

ASOLA MAXI - MAXI TERMINAL BLOCK HOLE

HxL	300x65
-----	--------

Previa verifica strutturale - Structural verification required
Altre su richiesta - Others upon request

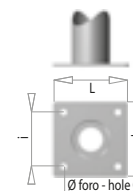

PIASTRA - PLATE

	i	LxL	Ø Foro Hole Ø	Spessore Thickness
DS 3	180	250x250	22	10
DS 3,5	180	250x250	22	10
DS 4	180	250x250	22	10

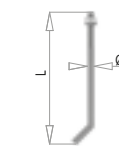

KIT TIRAFONDI - ANCHOR BOLTS

L	500
Ø	M 18

Valori espressi in millimetri | Measures in millimeters

DS

Palo in acciaio a sezione circolare realizzato in un unico tratto con codolo finale, composto da elementi tubolari saldati in sequenza. Asola ingresso cavi e asola per morsetti con finitura dei bordi del taglio idonea anche per l'applicazione di portella incassata a filo palo. Zincatura a caldo secondo la norma ISO 1461 e successiva spazzolatura per garantire una perfetta finitura superficiale. Verniciatura a polveri poliesteri.
Cod. 01,02,03,04, RAL su richiesta.

Circular cross section steel pole consisting of one single section with end spigot, made of tubular elements welded in sequence. Cable inlet slot and terminal box slot with finished edges, also suitable for the application of a flush mounted cover door.
Hot galvanized in accordance with ISO 1461, and subsequent brushing to ensure perfect surface finish. Polyester powder coating.
Code 01,02,03,04, RAL on request.

		DS 3	DS 3,5	DS 4	
DIMENSIONI DIMENSIONS	D1	1° Tratto (Ø x spessore) 1 st Section (Ø x thickness)	102x3 mm	102x3 mm	102x3 mm
	D2	Codolo finale (Ø x spessore) Final spigot (Ø x thickness)	60x3 mm	60x3 mm	60x3 mm
MATERIALI MATERIALS	D1	1° Tratto 1 st Section	S235 JR	S235 JR	S235 JR
	D2	Codolo finale Final spigot	S235 JR	S235 JR	S235 JR
LAVORAZIONI FINISHING	A1	Asola morsettiere Terminal block hole	186x45 mm	186x45 mm	186x45 mm
	A2	Asola ingresso cavi Cable slot	132x38 mm	132x38 mm	132x38 mm
	T	Messa a terra Grounding	Inserito filettato M10, zincato - M10 threaded, galvanized insert		
ALTEZZA HEIGHT	H	Altezza punto luce Luminaire height	3000 mm	3500 mm	4000 mm
	H1	Altezza portella Hatch height	800 mm	800 mm	800 mm
	H2	Asola passaggio cavi Cable slot height	200 mm	200 mm	200 mm
INTERRAMENTO IN-GROUNDING	P		500 mm	500 mm	500 mm
PESO WEIGHT			26 kg	30 kg	34 kg

La scelta del palo è soggetta a verifica strutturale effettuata in base alla zona di installazione. AEC procede al dimensionamento e alla verifica della resistenza del sostegno secondo la normativa EN-40.

The pole must be chosen after a structural pole test depending on the area of installation. AEC verifies the dimensioning and the resistance of the column according to the EN-40 standard.

10

9

8

7

6

5,5

5

4

3

Valori espressi in metri | Measures in metres

ACCESSORI ACCESSORIES

EC

SEZIONE UNICA | SINGLE SECTION

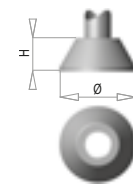

BASE BA/1

H	160
Ø	260



PORTELLA CON MORSETTIERA
TERMINAL BLOCK WITH HATCH

	Standard Standard	Filo palo Flush mounted
EC 5 A	T-39	RESET 11
EC 5 B	T-39	RESET 11
EC 5,5 A	T-39	RESET 11
EC 5,5 B	T-39	RESET 11

Disponibili a 1 o 2 fusibili - Available with 1 or 2 fuses

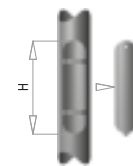

ASOLA MAXI - MAXI TERMINAL BLOCK HOLE

HxL	300x65
------------	--------

Previa verifica strutturale - Structural verification required
Altre su richiesta - Others upon request

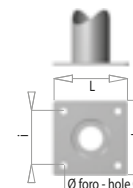

PIASTRA - PLATE

	i	LxL	Ø Foro Hole Ø	Spessore Thickness
EC 5 A	180	250x250	22	10
EC 5 B	180	250x250	22	10
EC 5,5 A	180	250x250	22	10
EC 5,5 B	180	250x250	22	10

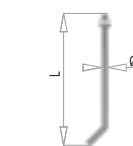

KIT TIRAFONDI - ANCHOR BOLTS

L	500
Ø	M 18

Valori espressi in millimetri | Measures in millimeters

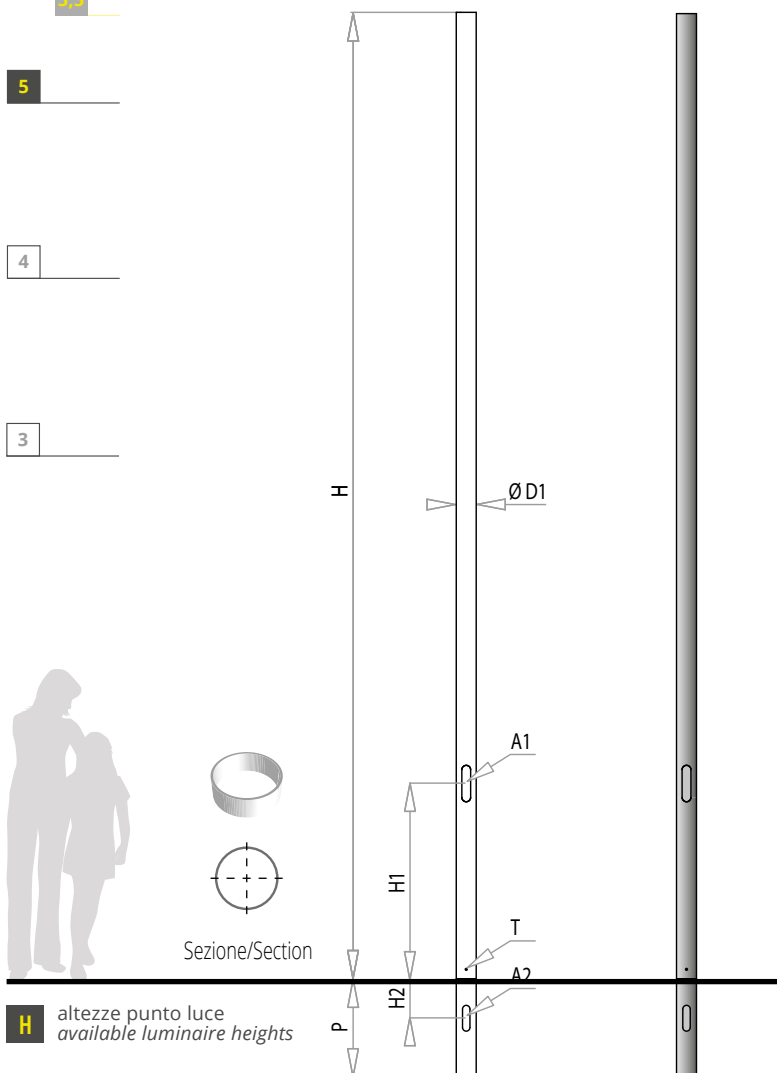

H altezze punto luce
available luminaire heights

Palo in acciaio a sezione circolare realizzato in un unico tratto. Asola ingresso cavi e asola per morsettiera con finitura dei bordi del taglio idonea anche per l'applicazione di portella incassata a filo palo.

Zincatura a caldo secondo la norma ISO 1461 e successiva spazzolatura per garantire una perfetta finitura superficiale. Verniciatura a polveri poliesteri.

Cod. 01,02,03,04, RAL su richiesta.

Circular cross section steel pole consisting of one single section. Cable inlet slot and terminal box slot with finished edges, also suitable for the application of a flush mounted cover door.

Hot galvanized in accordance with ISO 1461, and subsequent brushing to ensure perfect surface finish. Polyester powder coating.

Code 01,02,03,04, RAL on request.

		EC 5 A	EC 5 B	EC 5,5 A	EC 5,5 B	
DIMENSIONI DIMENSIONS	D1	Tratto unico (Ø x spessore) Single section (Ø x thickness)	102x3mm	102x3 mm	102x3 mm	102x3 mm
MATERIALI MATERIALS		Tratto unico Single section	S235 JR	S355 JR	S235 JR	S355 JR
LAVORAZIONI FINISHING	A1	Asola morsettiera Terminal block hole	186x45 mm	186x45 mm	186x45 mm	186x45 mm
	A2	Asola ingresso cavi Cable slot	132x38 mm	132x38 mm	132x38 mm	132x38 mm
	T	Messa a terra Grounding	Inserito filettato M10, zincato - M10 threaded, galvanized insert			
ALTEZZA HEIGHT	H	Altezza punto luce Luminaire height	5000 mm	5000 mm	5500 mm	5500 mm
	H1	Altezza portella Hatch height	1000 mm	1000 mm	1000 mm	1000 mm
	H2	Asola passaggio cavi Cable slot height	200 mm	200 mm	200 mm	200 mm
INTERRAMENTO IN-GROUNDING	P		500 mm	500 mm	500 mm	500 mm
PESO WEIGHT			40 kg	40 kg	43,5 kg	43,5 kg

I pali riportati in tabella sono verificati con i seguenti parametri: A: 1 braccio per un apparecchio fino a 25 m/s in categoria II; B: 2 bracci per 2 apparecchi fino a 29 m/s in categoria II. La scelta del palo è soggetta a verifica strutturale effettuata in base alla zona di installazione. AEC procede al dimensionamento e alla verifica della resistenza del sostegno secondo la normativa EN-40.

The poles in the table are verified according to: A: 1 bracket for 1 luminaire up to 25m/s in category II; B: 2 brackets for 2 luminaires up to 29m/s in category II. The pole must be chosen after a structural pole test depending on the area of installation. AEC verifies the dimensioning and the resistance of the column according to the EN-40 standard.

10

9

8

7

6

5

4

3

Valori espressi in metri | Measures in metres

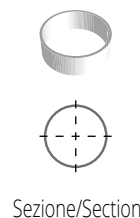

Sezione/Section

H altezze punto luce
available luminaire heights

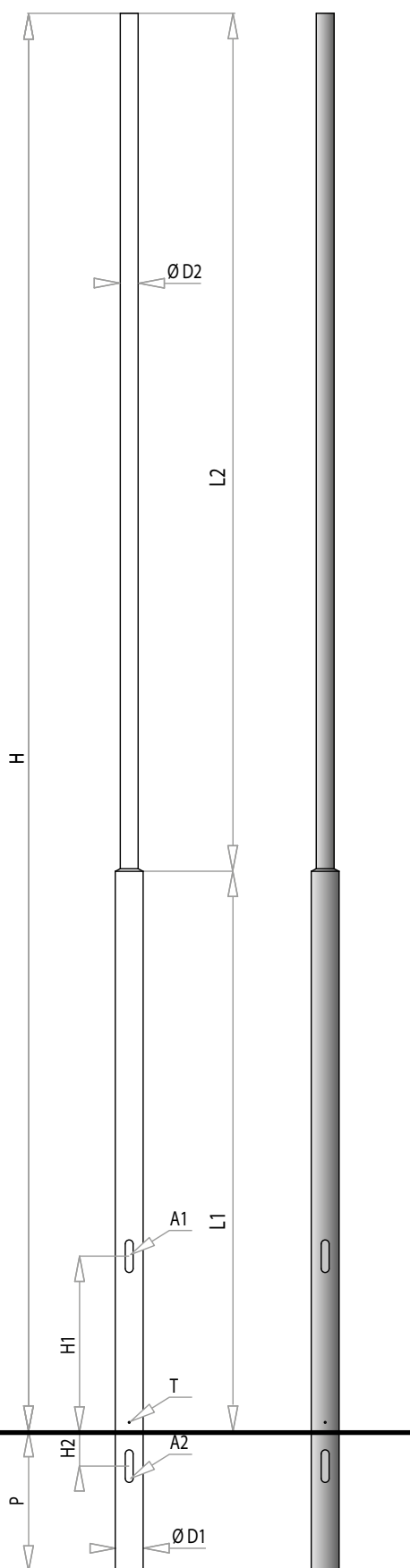

ACCESSORI ACCESSORIES



PORTELLA CON MORSETTIERA
TERMINAL BLOCK WITH HATCH

	Standard Standard	Filo palo Flush mounted
EC 6	T-39 G	RESET 18
EC 7	T-39 G	RESET 18
EC 8	T-39 G	RESET 18
EC 9	T-39 G	RESET 18

Disponibili a 1 o 2 fusibili - Available with 1 or 2 fuses

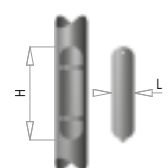

ASOLA MAXI - MAXI TERMINAL BLOCK HOLE

HxL	
	300x65
	400x90

Previa verifica strutturale - Structural verification required
Altre su richiesta - Others upon request

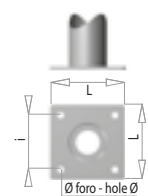

PIASTRA - PLATE

	i	LxL	Ø Foro Hole Ø	Spessore Thickness
EC 6	180	250x250	22	10
EC 7	180	250x250	22	10
EC 8	180	250x250	22	10
EC 9	300	400x400	33	20
EC 10	300	400x400	33	20

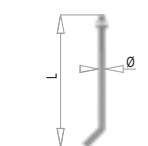

KIT TIRAFONDI - ANCHOR BOLTS

	EC 6 - EC 7 - EC 8	EC 9 - EC 10
L	500	700
Ø	M 18	M 27

Valori espressi in millimetri | Measures in millimeters

EC
RASTREMATO | TAPERED

Palo in acciaio a sezione circolare rastremato con rondella d'acciaio tornita, composto da due tratti, realizzato con elementi tubolari saldati in sequenza. Asola ingresso cavi e asola per morsettiera con finitura dei bordi del taglio idonea anche per l'applicazione di portella incassata a filo palo. Zincatura a caldo secondo la norma ISO 1461 e successiva spazzolatura per garantire una perfetta finitura superficiale. Verniciatura a polveri poliesteri. Cod. 01,02,03,04, RAL su richiesta.

Circular cross section tapered steel pole with turned steel gasket, consisting of two sections, made of tubular elements welded in sequence. Cable inlet slot and terminal box slot with finished edges, also suitable for the application of a flush mounted cover door.

Hot galvanized in accordance with ISO 1461, and subsequent brushing to ensure perfect surface finish. Polyester powder coating. Code 01,02,03,04, RAL on request.

		EC 6	EC 7	EC 8	EC 9	EC 10
DIMENSIONI DIMENSIONS	D1	1° Tratto (Ø x spessore) 1 st Section (Ø x thickness)	159x3 mm	159x3 mm	159x3 mm	159x3 mm
	L1	Lunghezza 1° Tratto 1 st Section length	2200 mm	3200 mm	3200 mm	4000 mm
	D2	2° Tratto (Ø x spessore) 2 nd Section (Ø x thickness)	102x3 mm	102x3 mm	102x3 mm	102x3 mm
	L2	Lunghezza 2° Tratto 2 nd Section length	3800 mm	3800 mm	4500 mm	5500 mm
	MATERIALI MATERIALS	D1	1° Tratto 1 st Section	S235 JR	S235 JR	S235 JR
D2		2° Tratto 2 nd Section	S235 JR	S235 JR	S235 JR	S355 JR
LAVORAZIONI FINISHING	A1	Asola morsettiera Terminal block hole	186x45 mm	186x45 mm	186x45 mm	186x45 mm
	A2	Asola ingresso cavi Cable slot	186x45 mm	186x45 mm	186x45 mm	186x45 mm
	T	Messa a terra Grounding	Inserito filettato M10, zincato - M10 threaded, galvanized insert			
ALTEZZA HEIGHT	H	Altezza punto luce Luminaire height	6000 mm	7000 mm	7700 mm	9000 mm
	H1	Altezza portella Hatch height	1000 mm	1000 mm	1000 mm	1000 mm
	H2	Asola passaggio cavi Cable slot height	200 mm	200 mm	200 mm	200 mm
INTERRAMENTO IN-GROUNDING	P		800 mm	800 mm	800 mm	1000 mm
PESO WEIGHT			65 kg	77 kg	82 kg	95 kg

La scelta del palo è soggetta a verifica strutturale effettuata in base alla zona di installazione. AEC procede al dimensionamento e alla verifica della resistenza del sostegno secondo la normativa EN-40.

The pole must be chosen after a structural pole test depending on the area of installation. AEC verifies the dimensioning and the resistance of the column according to the EN-40 standard.

10

9

8

7

6

5

4

3,5

3

Valori espressi in metri | Measures in metres

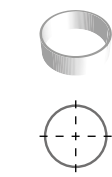

Sezione/Section

H altezze punto luce
available luminaire heights

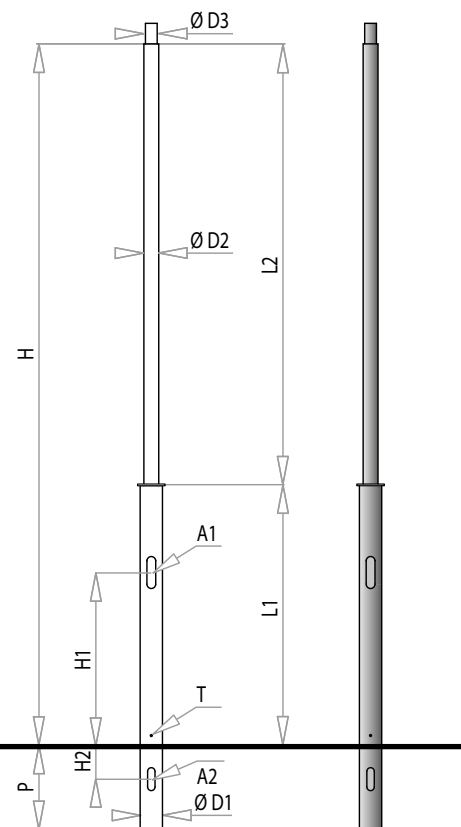

ACCESSORI ACCESSORIES



PORTELLA CON MORSETTIERA TERMINAL BLOCK WITH HATCH

	Standard Standard	Filo palo Flush mounted
PU 3,5	T-39	RESET 12
PU 4	T-39	RESET 12

Disponibili a 1 o 2 fusibili - Available with 1 or 2 fuses

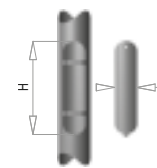

ASOLA MAXI - MAXI TERMINAL BLOCK HOLE

HxL	
	300x65
	400x75

Previa verifica strutturale - Structural verification required
Altre su richiesta - Others upon request

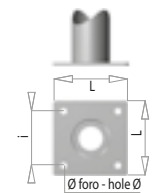

PIASTRA - PLATE

	i	LxL	Ø Foro Hole Ø	Spessore Thickness
PU 3,5	180	250x250	22	10
PU 4	180	250x250	22	10

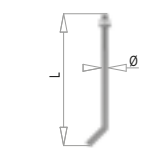

KIT TIRAFONDI - ANCHOR BOLTS

L	
	500
Ø	
	M 18

Valori espressi in millimetri | Measures in millimeters

PU

Palo in acciaio a sezione circolare rastremato con rondella di giunzione a forma piatta in acciaio tornito, composto da due tratti, realizzato con elementi tubolari saldati in sequenza. Codolo attacco apparecchio testa palo. Asola ingresso cavi e asola per morsettiera con finitura dei bordi del taglio idonea anche per l'applicazione di portella incassata a filo palo. Zincatura a caldo secondo la norma ISO 1461 e successiva spazzolatura per garantire una perfetta finitura superficiale. Verniciatura a polveri poliesteri. Cod. 01,02,03,04, RAL su richiesta.

Circular cross section tapered steel pole with a turned steel plain junction gasket, consisting of two sections, with tubular elements welded in sequence. Unit connection spigot at the top of the pole. Cable inlet slot and terminal box slot with finished edges, also suitable for the application of a flush mounted cover door. Hot galvanized in accordance with ISO 1461, and subsequent brushing to ensure perfect surface finish. Polyester powder coating. Code 01,02,03,04, RAL on request.

		PU 3,5	PU 4	
DIMENSIONI DIMENSIONS	D1	1° Tratto (Ø x spessore) 1 st Section (Ø x thickness)	114x3 mm	114x3 mm
	L1	Lunghezza 1° Tratto - 1 st Section length	1000 mm	1000 mm
	D2	2° Tratto (Ø x spessore) 2 nd Section (Ø x thickness)	76x3 mm	76x3 mm
	L2	Lunghezza 2° Tratto - 2 nd Section length	2500 mm	3000 mm
	D3	Codolo finale (Ø x spessore) Ending spigot (Ø x thickness)	60x3 mm	60x3 mm
MATERIALI MATERIALS	D1	1° Tratto - 1 st Section	S235 JR	S235 JR
	D2	2° Tratto - 2 nd Section	S235 JR	S235 JR
LAVORAZIONI FINISHING	A1	Asola morsettiera - Terminal block hole	186x45 mm	186x45 mm
	A2	Asola ingresso cavi - Cable slot	132x38 mm	132x38 mm
	T	Messa a terra - Grounding	Inserito filettato M10, zincato M10 threaded, galvanized insert	
ALTEZZA HEIGHT	H	Altezza punto luce - Luminaire height	3500 mm	4000 mm
	H1	Altezza portella - Hatch height	600 mm	600 mm
	H2	Asola passaggio cavi - Cable slot height	200 mm	200 mm
INTERRAMENTO IN-GROUNDING	P		500 mm	500 mm
PESO WEIGHT			26 kg	30 kg

La scelta del palo è soggetta a verifica strutturale effettuata in base alla zona di installazione. AEC procede al dimensionamento e alla verifica della resistenza del sostegno secondo la normativa EN-40.

The pole must be chosen after a structural pole test depending on the area of installation. AEC verifies the dimensioning and the resistance of the column according to the EN-40 standard.

10

9

8

7

6

5

4

3

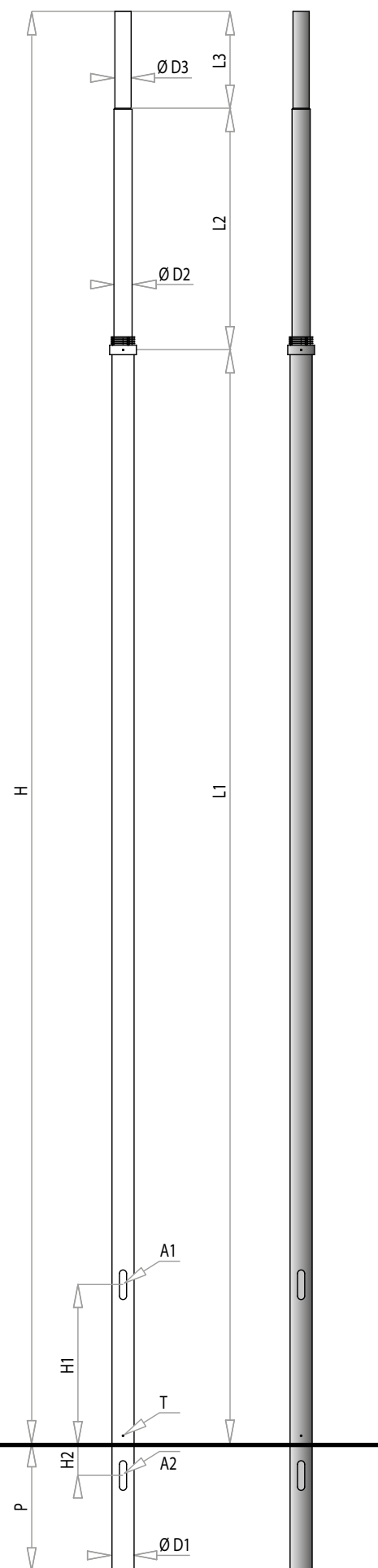

ACCESSORI ACCESSORIES

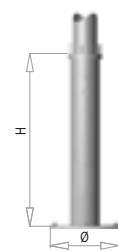

BASE BQ

	Ø A	Ø B	H
PQ 5	140	350	1077
PQ 6	159	350	1077
PQ 7	159	350	1277
PQ 8	168	400	1277
PQ 9	168	400	1577
PQ 10	168	400	1577



PORTELLA CON MORSETTIERA TERMINAL BLOCK WITH HATCH

	Standard Standard	Filo palo Flush mounted
PQ 5	T-39	RESET 11
PQ 6	T-39 G	RESET 16
PQ 7	T-39 G	RESET 16
PQ 8	T-39 G	RESET 17
PQ 9	T-39 G	RESET 17
PQ 10	T-39 G	RESET 17

Disponibili a 1 o 2 fusibili - Available with 1 or 2 fuses

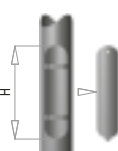

ASOLA MAXI - MAXI TERMINAL BLOCK HOLE

HxL	
	300x65
	400x90*

Previa verifica strutturale - Structural verification required
Altre su richiesta - Others upon request
*Escluso PQ5 - Except PQ5.

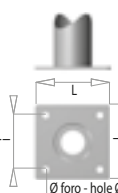

PIASTRA - PLATE

	i	LxL	Ø Foro Hole Ø	Spessore Thickness
PQ 5	180	250x250	22	15
PQ 6	180	250x250	22	15
PQ 7	180	250x250	22	15
PQ 8	180	250x250	22	15
PQ 9	260	350x350	30	20
PQ 10	260	350x350	30	20



FINALE ALETTATO - TOP DECOR

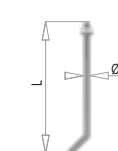

KIT TIRAFONDI - ANCHOR BOLTS

	PQ 5 - PQ 6 - PQ 7 - PQ 8	PQ 9 - PQ 10
L	500	700
Ø	M 18	M 27

Valori espressi in millimetri | Measures in millimeters

PQ

Palo in acciaio a sezione circolare con rastremature stampate, composto da due tratti (solo versione PQ 5) e tre tratti, realizzato con elementi tubolari raccordati e saldati in sequenza. Il palo è dotato di decoro alettato copri-rastrematura in acciaio. Asola ingresso cavi e asola per morsettiera con finitura dei bordi del taglio idonea anche per l'applicazione di portella incassata a filo palo. Zincatura a caldo secondo la norma ISO 1461 e successiva spazzolatura per garantire una perfetta finitura superficiale. Verniciatura a polveri poliestere. Cod. 01,02,03,04, RAL su richiesta.

Circular cross section steel pole with formed tapering, consisting of two sections (PQ 5 version only) or three sections, made of tubular joint elements welded in sequence. The pole has a finned steel trim to cover the tapering. Cable inlet slot and terminal box slot with finished edges, also suitable for the application of a flush mounted cover door. Hot galvanized in accordance with ISO 1461, and subsequent brushing to ensure perfect surface finish. Polyester powder coating. Code 01,02,03,04, RAL on request.

		PQ 5	PQ 6	PQ 7	PQ 8	PQ 9	PQ 10
DIMENSIONI DIMENSIONS	D1	1° Tratto (Ø x spessore) 1 st Section (Ø x thickness)	102x3 mm	127x3 mm	127x3 mm	139x3 mm	139x4 mm
	L1	Lunghezza 1° Tratto 1 st Section length	4400 mm	4400 mm	5200 mm	6200 mm	6900 mm
	D2	2° Tratto (Ø x spessore) 2 nd Section (Ø x thickness)	-	102x3 mm	102x3 mm	114x3 mm	114x3 mm
	L2	Lunghezza 2° Tratto 2 nd Section length	-	1000 mm	1200 mm	1200 mm	1500 mm
	D3	3° Tratto (Ø x spessore) 3 rd Section (Ø x thickness)	89x3 mm	89x3 mm	89x3 mm	102x3 mm	102x3 mm
	L3	Lunghezza 3° Tratto 3 rd Section length	600 mm	600 mm	600 mm	600 mm	600 mm
MATERIALI MATERIALS	D1	1° Tratto - 1 st Section	S235 JR	S235 JR	S235 JR	S235 JR	S235 JR
	D2	2° Tratto - 2 nd Section	-	S235 JR	S235 JR	S235 JR	S235 JR
	D3	3° Tratto - 3 rd Section	S235 JR	S235 JR	S235 JR	S235 JR	S235 JR
LAVORAZIONI FINISHING	A1	Asola morsettiera Terminal block hole	186x45 mm	186x45 mm	186x45 mm	186x45 mm	186x45 mm
	A2	Asola ingresso cavi Cable slot	132x38 mm	186x45 mm	186x45 mm	186x45 mm	186x45 mm
	T	Messa a terra Grounding	Insero filettato M10, zincato - M10 threaded, galvanized insert				
ALTEZZA HEIGHT	H	Altezza punto luce Luminaire height	5000 mm	6000 mm	7000 mm	8000 mm	9000 mm
	H1	Altezza portella Hatch height	800 mm	800 mm	800 mm	800 mm	1000 mm
	H2	Asola passaggio cavi Cable slot height	200 mm	200 mm	200 mm	200 mm	200 mm
INTERRAMENTO IN-GROUNDING	P		500 mm	800 mm	800 mm	800 mm	1000 mm
PESO - WEIGHT			40 kg	58 kg	68 kg	83 kg	122 kg

La scelta del palo è soggetta a verifica strutturale effettuata in base alla zona di installazione. AEC procede al dimensionamento e alla verifica della resistenza del sostegno secondo la normativa EN-40.

The pole must be chosen after a structural pole test depending on the area of installation. AEC verifies the dimensioning and the resistance of the column according to the EN-40 standard.

10

9

8

7

6

5

4

3

ACCESSORI ACCESSORIES

PG



BASE BG

H	574
Ø	360



PORTELLA CON MORSETTIERA
TERMINAL BLOCK WITH HATCH

	Standard Standard	Filo palo Flush mounted
PG 5	T-39 P	-
PG 6	T-39 G	RESET 12
PG 7	T-39 G	RESET 12

* Disponibili a 1 o 2 fusibili - Available with 1 or 2 fuses

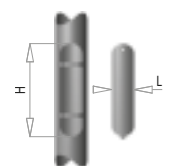

ASOLA MAXI - MAXI TERMINAL BLOCK HOLE

HxL	300x65*
-----	---------

Previa verifica strutturale - Structural verification required
Altre su richiesta - Others upon request

* Escluso PG 5. Except PG 5.

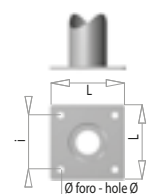

PIASTRA - PLATE

	i	LxL	Ø Foro Hole Ø	Spessore Thickness
PG 5	180	250x250	22	10
PG 6	180	250x250	22	10
PG 7	180	250x250	22	10

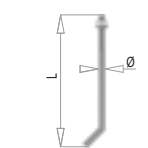

KIT TIRAFONDI - ANCHOR BOLTS

L	500
Ø	M 18

Valori espressi in millimetri | Measures in millimeters

Palo in acciaio a sezione circolare conica, HSP. Palo ottenuto mediante laminazione a caldo di tubo S275 JR saldato ERW. Asola ingresso cavi e asola per morsetti con finitura dei bordi del taglio idonea anche per l'applicazione di portella incassata a filo palo. Zincatura a caldo secondo la norma ISO 1461 e successiva spazzolatura per garantire una perfetta finitura superficiale. Verniciatura a polveri poliestere. Cod. 01,02,03,04, RAL su richiesta.

Conical circular section from a hot roll tube in S275 JR steel, ERW welded. Cable inlet slot and terminal box slot with finished edges, also suitable for the application of a flush mounted cover door. Hot galvanized in accordance with ISO 1461, and subsequent brushing to ensure perfect surface finish. Polyester powder coating. Code 01,02,03,04, RAL on request.

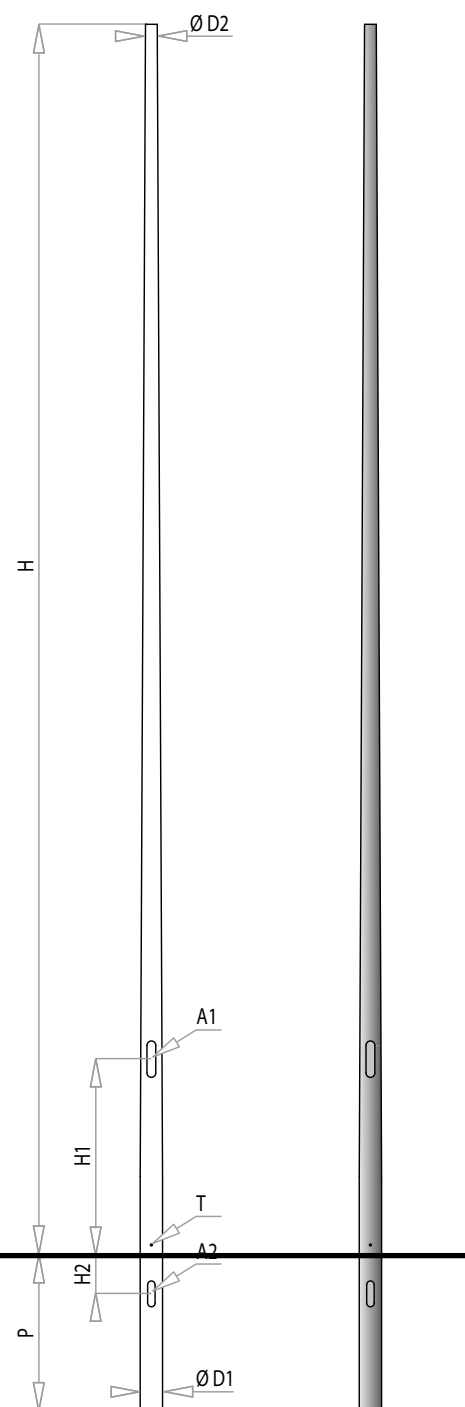

H altezze punto luce
available luminaire heights

		PG 5	PG 6	PG 7	
DIMENSIONI DIMENSIONS	D1	Dimensione alla base (Ø x spessore) Dimension at the base (Ø x thickness)	89x3,4 mm	114x3,4 mm	114x3,4 mm
	D2	Dimensione in testa (Ø) Dimension at the top (Ø)	60 mm	60 mm	60 mm
MATERIALI MATERIALS		Tratto unico Single section	S275 JR	S275 JR	S275 JR
LAVORAZIONI FINISHING	A1	Asola morsetti Terminal block hole	186x45 mm	186x45 mm	186x45 mm
	A2	Asola ingresso cavi Cable slot	132x38 mm	186x45 mm	186x45 mm
	T	Messa a terra Grounding	Insero filettato M10, zincato - M10 threaded, galvanized insert		
ALTEZZA HEIGHT	H	Altezza punto luce Luminaire height	5000 mm	6000 mm	7000 mm
	H1	Altezza portella Hatch height	1000 mm	1000 mm	1000 mm
	H2	Asola passaggio cavi Cable slot height	200 mm	200 mm	200 mm
INTERRAMENTO IN-GROUNDING	P		500 mm	800 mm	800 mm
PESO WEIGHT			30 kg	48 kg	57 kg

La scelta del palo è soggetta a verifica strutturale effettuata in base alla zona di installazione. AEC procede al dimensionamento e alla verifica della resistenza del sostegno secondo la normativa EN-40.

The pole must be chosen after a structural pole test depending on the area of installation. AEC verifies the dimensioning and the resistance of the column according to the EN-40 standard.

ACCESSORI ACCESSORIES

PK

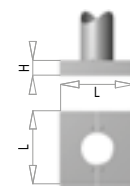
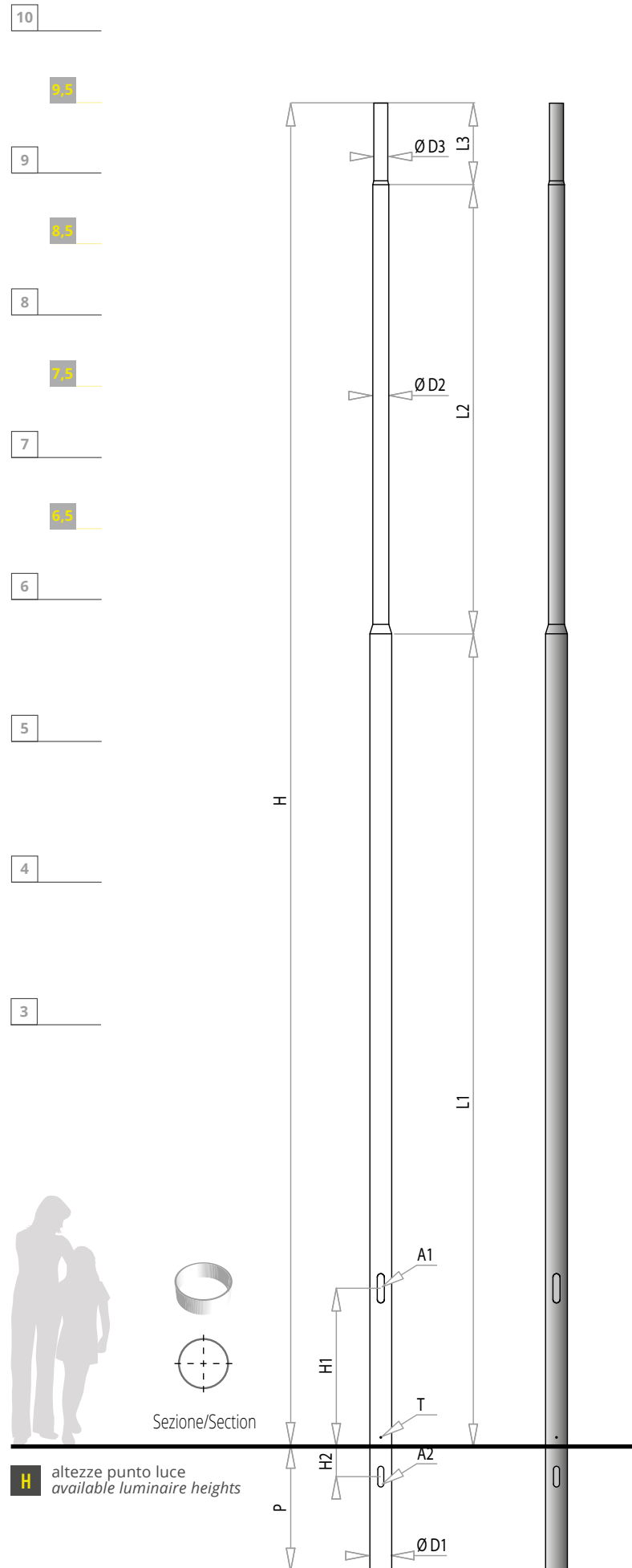

BASE BK

LxL	312x312
H	65

PORTELLA CON MORSETTIERA
TERMINAL BLOCK WITH HATCH

	Standard Standard	Filo palo Flush mounted
PK 6,5	T-39 G	RESET 16
PK 7,5	T-39 G	RESET 16
PK 8,5	T-39 G	RESET 17
PK 9,5	T-39 G	RESET 17

Disponibili a 1 o 2 fusibili - Available with 1 or 2 fuses

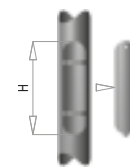

ASOLA MAXI - MAXI TERMINAL BLOCK HOLE

HxL	300x65
	400x90

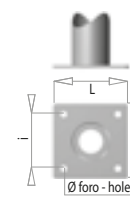
Previa verifica strutturale - Structural verification required
Altre su richiesta - Others upon request

PIASTRA - PLATE

	i	LxL	Ø Foro Hole Ø	Spessore Thickness
PK 6,5	180	250x250	22	15
PK 7,5	260	350x350	30	20
PK 8,5	260	350x350	30	20
PK 9,5	260	350x350	30	20

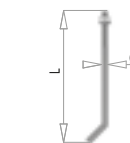

KIT TIRAFONDI - ANCHOR BOLTS

	PK 6,5	PK 7,5 - PK 8,5 - PK 9,5
L	500	700
Ø	M 18	M 27

Valori espressi in millimetri | Measures in millimeters

Palo in acciaio a sezione circolare con rastremature stampate, composto da tre tratti, realizzato con elementi tubolari raccordati e saldati in sequenza. Asola ingresso cavi e asola per morsetti con finitura dei bordi del taglio idonea anche per l'applicazione di portella incassata a filo palo.

Zincatura a caldo secondo la norma ISO 1461 e successiva spazzolatura per garantire una perfetta finitura superficiale. Verniciatura a polveri poliesteri. Cod. 01,02,03,04, RAL su richiesta.

Circular cross section steel pole with formed tapering, consisting of three sections, made of tubular joint elements welded in sequence. Cable inlet slot and terminal box slot with finished edges, also suitable for the application of a flush mounted cover door. Hot galvanized in accordance with ISO 1461, and subsequent brushing to ensure perfect surface finish. Polyester powder coating. Code 01,02,03,04, RAL on request.

		PK 6,5	PK 7,5 A	PK 7,5 B	PK 8,5 A	PK 8,5 B	PK 9,5 A	PK 9,5 B	
DIMENSIONI DIMENSIONS	D1	1° Tratto (Ø x spessore) 1 st Section (Ø x thickness)	127x3 mm	127x3 mm	127x4 mm	139x3 mm	139x4 mm	139x3 mm	139x4 mm
	L1	Lunghezza 1° Tratto 1 st Section length	3200 mm	3200 mm	3200 mm	5200 mm	5200 mm	5200 mm	5200 mm
	D2	2° Tratto (Ø x spessore) 2 nd Section (Ø x thickness)	102x3 mm	102x3 mm	102x3 mm	102x3 mm	102x3 mm	102x3 mm	102x3 mm
	L2	Lunghezza 2° Tratto 2 nd Section length	2800 mm	3800 mm	3800 mm	2800 mm	2800 mm	3800 mm	3800 mm
	D3	3° Tratto (Ø x spessore) 3 rd Section (Ø x thickness)	89x3 mm	89x3 mm	89x3 mm	89x3 mm	89x3 mm	89x3 mm	89x3 mm
MATERIALI MATERIALS	L3	Lunghezza 3° Tratto 3 rd Section length	500 mm	500 mm	500 mm	500 mm	500 mm	500 mm	500 mm
	D1	1° Tratto 1 st Section	S235 JR	S235 JR	S235 JR	S235 JR	S235 JR	S235 JR	S355 JR
	D2	2° Tratto 2 nd Section	S235 JR	S235 JR	S235 JR	S235 JR	S235 JR	S235 JR	S235 JR
LAVORAZIONI FINISHING	D3	3° Tratto 3 rd Section	S235 JR	S235 JR	S235 JR	S235 JR	S235 JR	S235 JR	S235 JR
	A1	Asola morsetti Terminal block hole	186x45 mm	186x45 mm	186x45 mm	186x45 mm	186x45 mm	186x45 mm	186x45 mm
	A2	Asola ingresso cavi Cable slot	132x38 mm	132x38 mm	132x38 mm	132x38 mm	132x38 mm	132x38 mm	132x38 mm
ALTEZZA HEIGHT	T	Messa a terra Grounding	Insero filettato M10, zincato - M10 threaded, galvanized insert						
	H	Altezza punto luce Luminaire height	6500 mm	7500 mm	7500 mm	8500 mm	8500 mm	9500 mm	9500 mm
	H1	Altezza portella Hatch height	1000 mm	1000 mm	1000 mm	1000 mm	1000 mm	1000 mm	1000 mm
INTERRAMENTO IN-GROUNDING	H2	Asola passaggio cavi Cable slot height	200 mm	200 mm	200 mm	200 mm	200 mm	200 mm	200 mm
	P		800 mm	800 mm	800 mm	800 mm	800 mm	800 mm	800 mm
PESO WEIGHT			60 kg	68 kg	79 kg	84 kg	104 kg	91 kg	111 kg

I pali riportati in tabella sono verificati con i seguenti parametri: A: 1 braccio per un apparecchio fino a 25 m/s in categoria II; B: 2 bracci per 2 apparecchi fino a 29 m/s in categoria II. La scelta del palo è soggetta a verifica strutturale effettuata in base alla zona di installazione. AEC procede al dimensionamento e alla verifica della resistenza del sostegno secondo la normativa EN-40.

The poles in the table are verified according to: A: 1 bracket for 1 luminaire up to 25m/s in category II; B: 2 brackets for 2 luminaires up to 29m/s in category II. The pole must be chosen after a structural pole test depending on the area of installation. AEC verifies the dimensioning and the resistance of the column according to the EN-40 standard.

ACCESSORI ACCESSORIES

PN

10

9

8,5

8

7,5

7

6,5

6

5

4

3

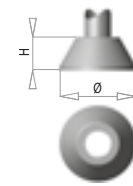
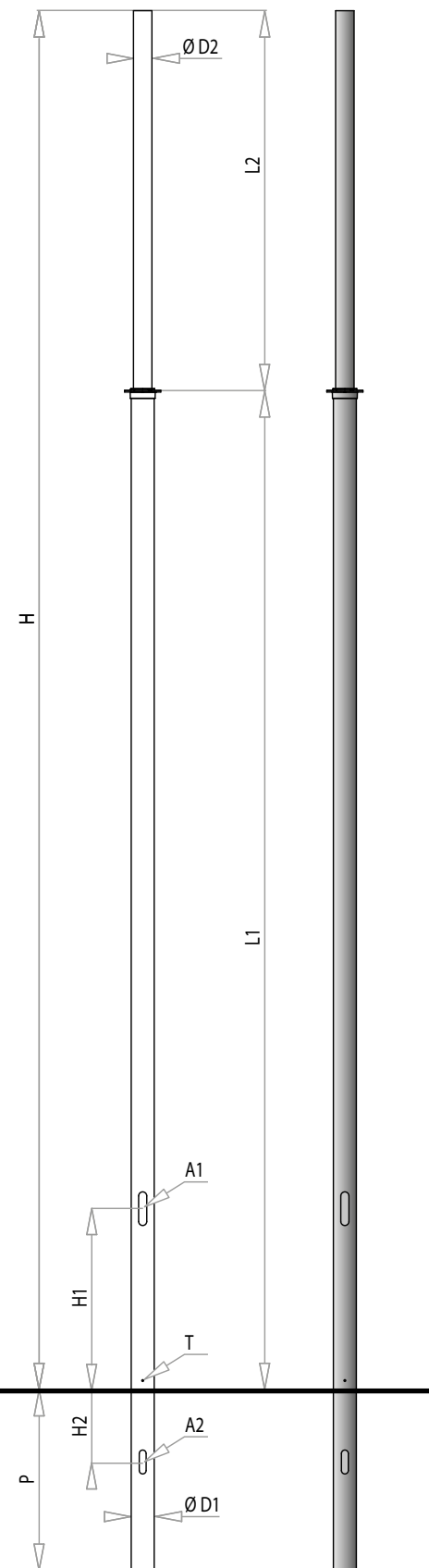

BASE BA/2

H	160
Ø	360

PORTELLA CON MORSETTIERA
TERMINAL BLOCK WITH HATCH

	Standard Standard	Filo palo Flush mounted
PN 6,5 A	T-39 G	RESET 16
PN 6,5 B	T-39 G	RESET 16
PN 7,5 A	T-39 G	RESET 16
PN 7,5 B	T-39 G	RESET 16
PN 8,5 A	T-39 G	RESET 16
PN 8,5 B	T-39 G	RESET 16

Disponibili a 1 o 2 fusibili - Available with 1 or 2 fuses

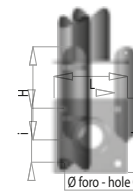

ASOLA MAXI - MAXI TERMINAL BLOCK HOLE

HxL	300x85
	400x90

Previa verifica strutturale - Structural verification required
Altre su richiesta - Others upon request

PIASTRA - PLATE

	i	LxL	Ø Foro Hole Ø	Spessore Thickness
PN 6,5 A	180	250x250	22	10
PN 6,5 B	180	250x250	22	15
PN 7,5 A	180	250x250	22	15
PN 7,5 B	180	250x250	22	15
PN 8,5 A	180	250x250	22	15
PN 8,5 B	180	250x250	22	15

KIT TIRAFONDI - ANCHOR BOLTS

L	500
Ø	M 18

Valori espressi in millimetri | Measures in millimeters

Palo in acciaio a sezione circolare con rastrematura stampata, composto da due tratti, realizzato con elementi tubolari raccordati e saldati in sequenza. Il palo è dotato di decoro copri-rastrematura realizzato in alluminio pressofuso. Asola ingresso cavi e asola per morsettiera con finitura dei bordi del taglio idonea anche per l'applicazione di portella incassata. Zincatura a caldo secondo la norma ISO 1461 e successiva spazzolatura per garantire una perfetta finitura superficiale. Verniciatura a polveri poliestere. Cod. 01,02,03,04, RAL su richiesta.

Circular cross section steel pole with formed tapering, consisting of two sections, made of tubular joint elements welded in sequence. The pole is fitted with pressure die-cast aluminium trim to cover the tapering. Cable inlet slot and terminal box slot with finished edges, also suitable for the application of a flush mounted cover door. Hot galvanized in accordance with ISO 1461, and subsequent brushing to ensure perfect surface finish. Polyester powder coating. Code 01,02,03,04, RAL on request.

		PN 6,5 A	PN 6,5 B	PN 7,5 A	PN 7,5 B	PN 8,5 A	PN 8,5 B
DIMENSIONI DIMENSIONS	D1	1° Tratto (Ø x spessore) 1 st Section (Ø x thickness)	127x3 mm	127x3 mm	127x3 mm	127x4 mm	127x4 mm
	L1	Lunghezza 1° Tratto 1 st Section length	4700 mm	4700 mm	5200 mm	5200 mm	6000 mm
	D2	2° Tratto (Ø x spessore) 2 nd Section (Ø x thickness)	102x3 mm	102x3 mm	102x3 mm	102x3 mm	102x3 mm
	L2	Lunghezza 2° Tratto 2 nd Section length	1800 mm	1800 mm	2300 mm	2300 mm	2500 mm
MATERIALI MATERIALS	D1	1° Tratto - 1 st Section	S235 JR	S355 JR	S355 JR	S355 JR	S355 JR
	D2	2° Tratto - 2 nd Section	S235 JR	S235 JR	S235 JR	S235 JR	S235 JR
LAVORAZIONI FINISHING	A1	Asola morsettiera Terminal block hole	186x45 mm	186x45 mm	186x45 mm	186x45 mm	186x45 mm
	A2	Asola ingresso cavi Cable slot	132x38 mm	132x38 mm	132x38 mm	132x38 mm	132x38 mm
	T	Messa a terra Grounding	Inserito filettato M10, zincato - M10 threaded, galvanized insert				
ALTEZZA HEIGHT	H	Altezza punto luce Luminaire height	6500 mm	6500 mm	7500 mm	7500 mm	8500 mm
	H1	Altezza portella Hatch height	1000 mm	1000 mm	1000 mm	1000 mm	1000 mm
	H2	Asola passaggio cavi Cable slot height	200 mm	200 mm	200 mm	200 mm	200 mm
INTERRAMENTO IN-GROUNDING	P		800 mm	800 mm	800 mm	1000 mm	1000 mm
PESO WEIGHT			63 kg	63 kg	72 kg	90 kg	104 kg

I pali riportati in tabella sono verificati con i seguenti parametri: A: 1 braccio per un apparecchio fino a 25 m/s in categoria II; B: 2 bracci per 2 apparecchi fino a 29 m/s in categoria II. La scelta del palo è soggetta a verifica strutturale effettuata in base alla zona di installazione. AEC procede al dimensionamento e alla verifica della resistenza del sostegno secondo la normativa EN-40.

The poles in the table are verified according to: A: 1 bracket for 1 luminaire up to 25m/s in category II; B: 2 brackets for 2 luminaires up to 29m/s in category II. The pole must be chosen after a structural pole test depending on the area of installation. AEC verifies the dimensioning and the resistance of the column according to the EN-40 standard.

ACCESSORI ACCESSORIES

PA

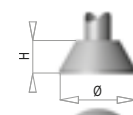
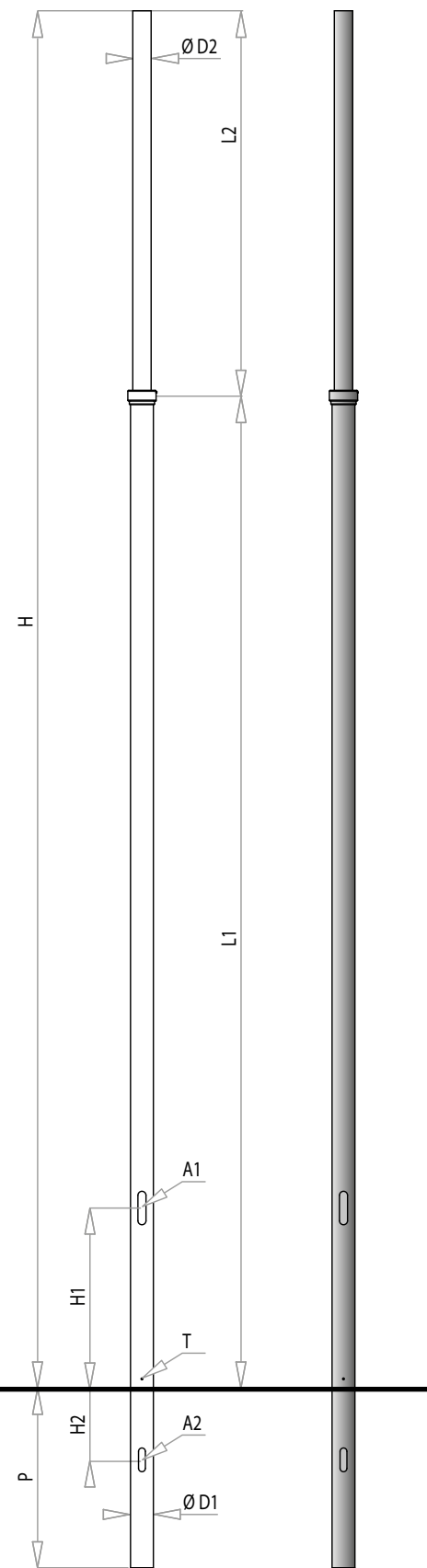

BASE BA/2

H	160
Ø	360

PORTELLA CON MORSETTIERA
TERMINAL BLOCK WITH HATCH

T-39



	Standard Standard	Filo palo Flush mounted
PA 6,5 A	T-39 G	RESET 16
PA 6,5 B	T-39 G	RESET 16
PA 7,5 A	T-39 G	RESET 16
PA 7,5 B	T-39 G	RESET 16
PA 8,5 A	T-39 G	RESET 16
PA 8,5 B	T-39 G	RESET 16

Disponibili a 1 o 2 fusibili - Available with 1 or 2 fuses

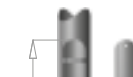

ASOLA MAXI - MAXI TERMINAL BLOCK HOLE

HxL	300x85
	400x90

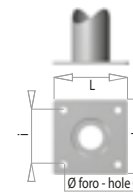
Previa verifica strutturale - Structural verification required
Altre su richiesta - Others upon request

PIASTRA - PLATE

	i	LxL	Ø Foro Hole Ø	Spessore Thickness
PA 6,5 A	180	250x250	22	10
PA 6,5 B	180	250x250	22	15
PA 7,5 A	180	250x250	22	15
PA 7,5 B	180	250x250	22	15
PA 8,5 A	180	250x250	22	15
PA 8,5 B	180	250x250	22	15

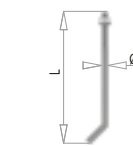

KIT TIRAFONDI - ANCHOR BOLTS

L	500
Ø	M 18

Valori espressi in millimetri | Measures in millimeters

Palo in acciaio a sezione circolare con rastrematura stampata, composto da due tratti e realizzato con elementi tubolari raccordati e saldati in sequenza. Il palo è dotato di decoro copri rastrematura realizzato in alluminio tornito.

Asola ingresso cavi e asola per morsettiera con finitura dei bordi del taglio idonea anche per l'applicazione di portella incassata a filo palo. Zincatura a caldo secondo la norma ISO 1461 e successiva spazzolatura per garantire una perfetta finitura superficiale. Verniciatura a polveri poliestere. Cod. 01,02,03,04, RAL su richiesta.

Circular cross section steel pole with formed tapering, consisting of two sections, made of tubular joint elements welded in sequence. The pole is fitted with turned aluminium trim to cover the tapering. Cable inlet slot and terminal box slot with finished edges, also suitable for the application of a flush mounted cover door. Hot galvanized in accordance with ISO 1461, and subsequent brushing to ensure perfect surface finish. Polyester powder coating. Code 01,02,03,04, RAL on request.

			PA 6,5 A	PA 6,5 B	PA 7,5 A	PA 7,5 B	PA 8,5 A	PA 8,5 B
DIMENSIONI DIMENSIONS	D1	1° Tratto (Ø x spessore) 1 st Section (Ø x thickness)	127x3 mm	127x3 mm	127x3 mm	127x4 mm	127x3 mm	127x4 mm
	L1	Lunghezza 1° Tratto 1 st Section length	4700 mm	4700 mm	5200 mm	5200 mm	6000 mm	6000 mm
	D2	2° Tratto (Ø x spessore) 2 nd Section (Ø x thickness)	102x3 mm	102x3 mm	102x3 mm	102x3 mm	102x3 mm	102x3 mm
	L2	Lunghezza 2° Tratto 2 nd Section length	1800 mm	1800 mm	2300 mm	2300 mm	2500 mm	2500 mm
MATERIALI MATERIALS	D1	1° Tratto - 1 st Section	S235 JR	S355 JR	S355 JR	S355 JR	S355 JR	S355 JR
	D2	2° Tratto - 2 nd Section	S235 JR	S235 JR	S235 JR	S235 JR	S235 JR	S235 JR
LAVORAZIONI FINISHING	A1	Asola morsettiera Terminal block hole	186x45 mm	186x45 mm	186x45 mm	186x45 mm	186x45 mm	186x45 mm
	A2	Asola ingresso cavi Cable slot	132x38 mm	132x38 mm	132x38 mm	132x38 mm	132x38 mm	132x38 mm
	T	Messa a terra Grounding	Inserto filettato M10, zincato - M10 threaded, galvanized insert					
ALTEZZA HEIGHT	H	Altezza punto luce Luminaire height	6500 mm	6500 mm	7500 mm	7500 mm	8500 mm	8500 mm
	H1	Altezza portella Hatch height	1000 mm	1000 mm	1000 mm	1000 mm	1000 mm	1000 mm
	H2	Asola passaggio cavi Cable slot height	200 mm	200 mm	200 mm	200 mm	200 mm	200 mm
INTERRAMENTO IN-GROUNDING	P		800 mm	800 mm	800 mm	800 mm	1000 mm	1000 mm
PESO WEIGHT			63 kg	63 kg	72 kg	90 kg	83 kg	104 kg

I pali riportati in tabella sono verificati con i seguenti parametri: A: 1 braccio per un apparecchio fino a 25 m/s in categoria II; B: 2 bracci per 2 apparecchi fino a 29 m/s in categoria II. La scelta del palo è soggetta a verifica strutturale effettuata in base alla zona di installazione. AEC procede al dimensionamento e alla verifica della resistenza del sostegno secondo la normativa EN-40.

The poles in the table are verified according to: A: 1 bracket for 1 luminaire up to 25m/s in category II; B: 2 brackets for 2 luminaires up to 29m/s in category II. The pole must be chosen after a structural pole test depending on the area of installation. AEC verifies the dimensioning and the resistance of the column according to the EN-40 standard.

10

9

8

7

6

5

4

3

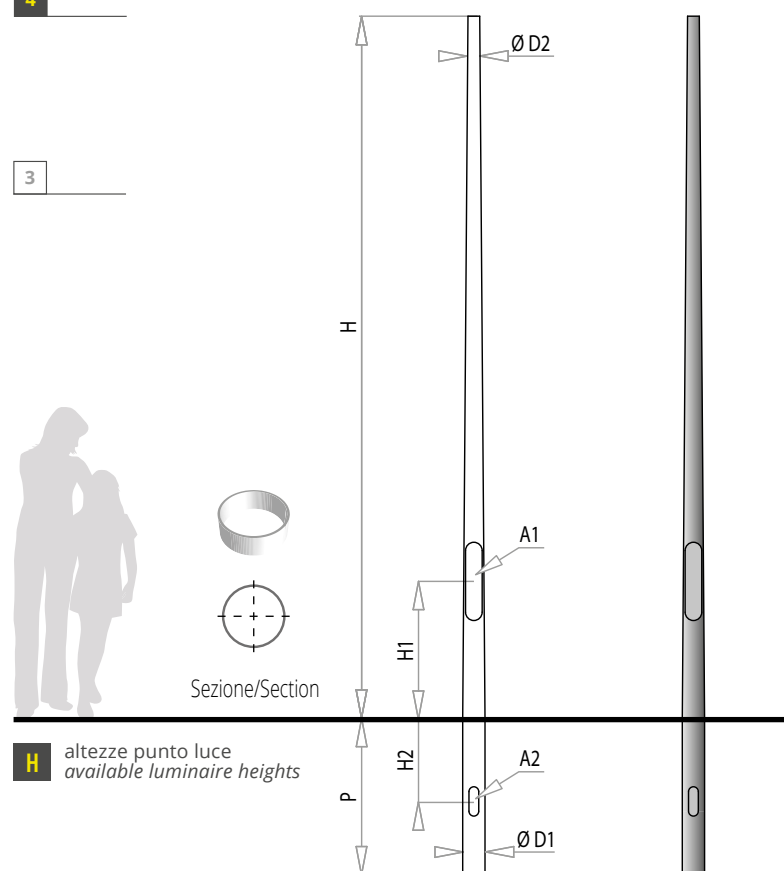

Palo in alluminio a sezione conica, trafilato, realizzato in un unico tratto. Asola ingresso cavi e portella integrata a filopalo.
Anodizzazione elettrolitica. Argento anodizzato.

*Conical cross section drawn aluminium pole consisting of one single section. Cable inlet slot and flush mounted cover door included. Electrolytic anodizing.
Anodized silver.*

		CA
DIMENSIONI DIMENSIONS	D1	\varnothing alla base - \varnothing at the base 114 mm
	D2	\varnothing in testa - \varnothing at the top 60 mm
MATERIALI MATERIALS		Tratto unico - Single section 6060 T5
LAVORAZIONI FINISHING	A1	Portella a filopalo - Reset 400x85 mm
	A2	Asola ingresso cavi - Cable slot 150x80 mm
ALTEZZA HEIGHT	H	Altezza punto luce - Luminaire height 4000 mm
	H1	Altezza portella - Hatch height 700 mm
	H2	Asola passaggio cavi - Cable slot height 575 mm
INTERRAMENTO IN-GROUNDING	P	800 mm
PESO WEIGHT		13 kg

La scelta del palo è soggetta a verifica strutturale effettuata in base alla zona di installazione. AEC procede al dimensionamento e alla verifica della resistenza del sostegno secondo la normativa EN-40.

The pole must be chosen after a structural pole test depending on the area of installation. AEC verifies the dimensioning and the resistance of the column according to the EN-40 standard.

10

9

8

7

6

5

4

3

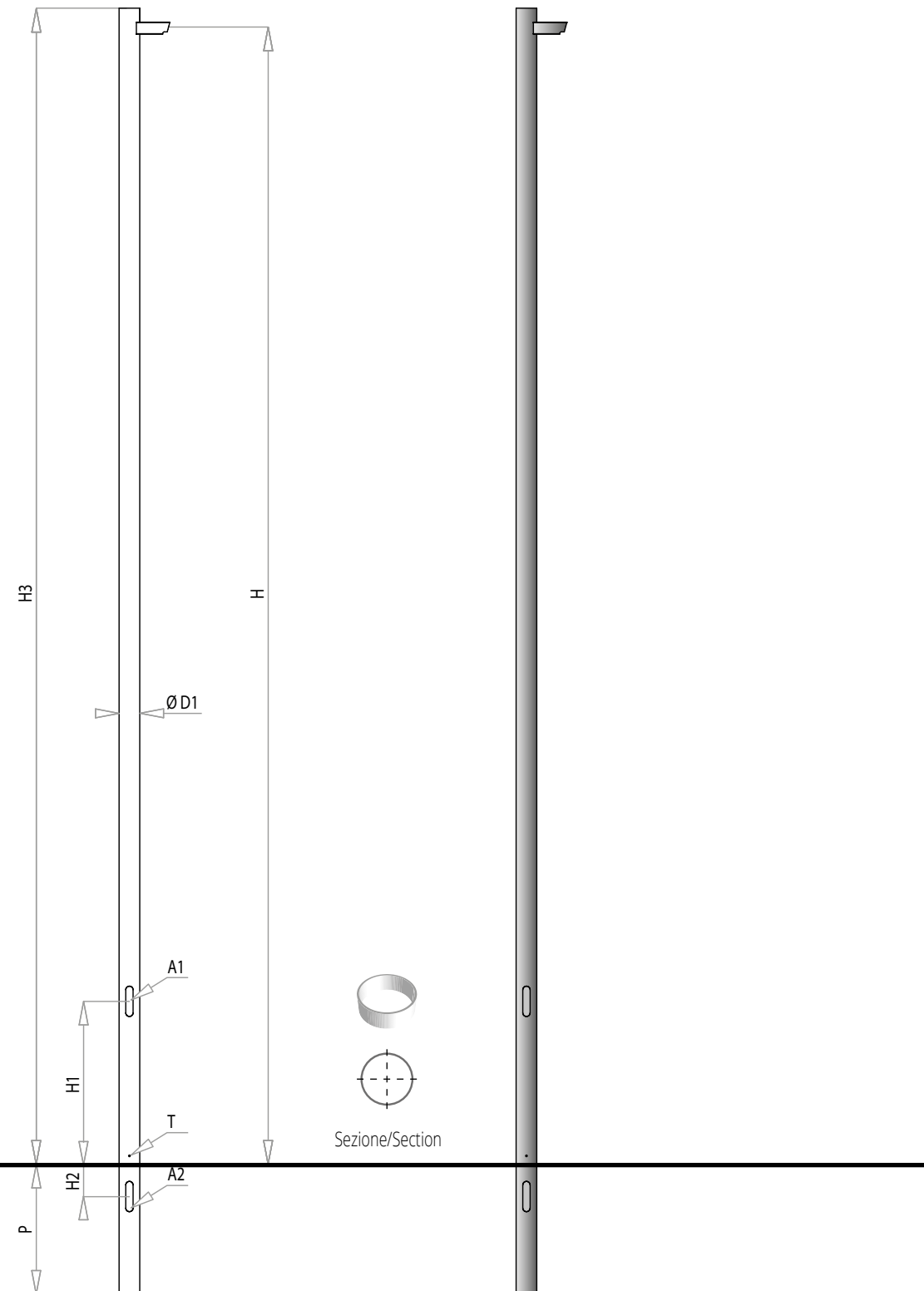

H altezze punto luce
available luminaire heights

PL

SISTEMA LOGIKA - Q QUADRO | LOGIKA AND Q QUADRO SYSTEM

Palo in acciaio a sezione circolare realizzato in un unico tratto. Il palo è dotato di bracci in alluminio trafilato per l'installazione di apparecchi della serie Logika e Q Quadro. I pali PL sono disponibili nelle versioni a 1, 2, 3 bracci. Asola ingresso cavi e asola per morsettiera con finitura dei bordi del taglio idonea anche per l'applicazione di portella incassata a filo palo. Zincatura a caldo secondo la norma ISO 1461 e successiva spazzolatura per garantire una perfetta finitura superficiale. Verniciatura a polveri poliesteri. Cod. 01,02,03,04, RAL su richiesta.

Circular cross section steel pole consisting of one single section. The pole is fitted with a drawn aluminium arm for the installation of units of the Logika and Q Quadro range. PL poles are available with 1, 2, and 3 brackets. Cable inlet slot and terminal box slot with finished edges, also suitable for the application of a flush mounted cover door. Hot galvanized in accordance with ISO 1461, and subsequent brushing to ensure perfect surface finish. Polyester powder coating. Code 01,02,03,04, RAL on request.



COMPOSIZIONI COMPOSITIONS

COMPOSIZIONE BRACCI LOGIKA 1 (L1) / LOGIKA 2 (L2) LOGIKA 1 (L1) / LOGIKA 2 (L2) BRACKET COMPOSITION

	PL 5	PL 6	PL 9	PL 10
▪	PL 5/1/L1 PL 5/1/L2	PL 6/1/L1 PL 6/1/L2	PL 7/1/L1 PL 7/1/L2	PL 8/1/L1 PL 8/1/L2
▪▪	PL 5/2/L1 PL 5/2/L2	PL 6/2/L1 PL 6/2/L2	PL 7/2/L1 PL 7/2/L2	PL 8/2/L1 PL 8/2/L2
▪▪▪	PL 5/3/L1	PL 6/3/L1 PL 6/3/L2	PL 7/3/L1 PL 7/3/L2	PL 8/3/L2

COMPOSIZIONE BRACCI Q3 QUADRO (Q3) / Q5 QUADRO (Q5) Q3 QUADRO (Q3) / Q5 QUADRO (Q5) BRACKET COMPOSITION

	PL 5	PL 6	PL 9	PL 10
▪	PL 5/1/Q3 PL 5/1/Q5	PL 6/1/Q3 PL 6/1/Q5	PL 7/1/Q3 PL 7/1/Q5	PL 8/1/Q3 PL 8/1/Q5
▪▪	PL 5/2/Q3 PL 5/2/Q5	PL 6/2/Q3 PL 6/2/Q5	PL 7/2/Q3 PL 7/2/Q5	PL 8/2/Q3 PL 8/2/Q5
▪▪▪	PL 5/3/Q3	PL 6/3/Q3 PL 6/3/Q5	PL 7/3/Q3 PL 7/3/Q5	PL 8/3/Q5

- Composizione a 1 braccio - 1 bracket mounting
- Composizione a 2 bracci - 2 brackets mounting
- Composizione a 3 bracci - 3 brackets mounting



Palo serie PL versione speciale con fissaggio inclinato.
PL pole series in a bended mounted special version.

ACCESSORI ACCESSORIES

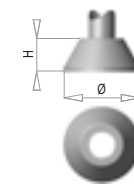

BASE BA/1

	PL 5
H	160
Ø	260

BASE BA/2

	PL 6 - PL 7 - PL 8
H	160
Ø	360



PORTELLA CON MORSETTIERA TERMINAL BLOCK WITH HATCH

	Standard Standard	Filo palo Flush mounted
PL 5	T-39	RESET 11
PL 6	T-39 G	RESET 16
PL 7	T-39 G	RESET 16
PL 8	T-39 G	RESET 16

Disponibili a 1 o 2 fusibili - Available with 1 or 2 fuses

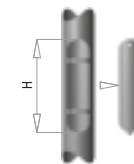

ASOLA MAXI - MAXI TERMINAL BLOCK HOLE

HxL	
	300x65
	400x90*

Previa verifica strutturale - Structural verification required
Altre su richiesta - Others upon request
* Escluso PX 4 - PX 5. Except PX 4 - PX 5.

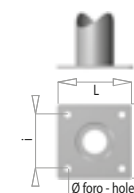

PIASTRA - PLATE

	i	LxL	Ø Foro Hole Ø	Spessore Thickness
PL 5	180	250x250	22	15
PL 6	180	250x250	22	15
PL 7	260	350x350	30	20
PL 8	260	350x350	30	20

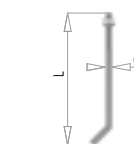

KIT TIRAFONDI - ANCHOR BOLTS

	PL 5 - PL 6	PL 7 - PL 8
L	500	700
Ø	M 18	M 27

Valori espressi in millimetri | Measures in millimeters

			PL 5	PL 6	PL 7	PL 8
DIMENSIONI DIMENSIONS	D1	Tratto unico (Ø x spessore) Single section (Ø x thickness)	102x3 mm	127x3 mm	127x3 mm	127x3 mm
MATERIALI MATERIALS		Tratto unico Single section	S235 JR	S235 JR	S235 JR	S235 JR
LAVORAZIONI FINISHING	A1	Asola morsettiera Terminal block hole	186x45 mm	186x45 mm	186x45 mm	186x45 mm
	A2	Asola ingresso cavi Cable slot	186x45 mm	186x45 mm	186x45 mm	186x45 mm
	T	Messa a terra Grounding	Inserito filettato M10, zincato - M10 threaded, galvanized insert			
ALTEZZA HEIGHT	H	Altezza punto luce Luminaire height	4900 mm	5900 mm	6900 mm	7900 mm
	H1	Altezza portella Hatch height	1000 mm	1000 mm	1000 mm	1000 mm
	H2	Asola passaggio cavi Cable slot height	200 mm	200 mm	200 mm	200 mm
	H3	Altezza fuori terra Above ground height	5000 mm	6000 mm	7000 mm	8000 mm
INTERRAMENTO IN-GROUNDING	P		500 mm	800 mm	800 mm	800 mm
PESO WEIGHT			40 kg	62 kg	70 kg	78 kg

La scelta del palo è soggetta a verifica strutturale effettuata in base alla zona di installazione. AEC procede al dimensionamento e alla verifica della resistenza del sostegno secondo la normativa EN-40.

The pole must be chosen after a structural pole test depending on the area of installation. AEC verifies the dimensioning and the resistance of the column according to the EN-40 standard.

10

9

8

7

6

5

4

3

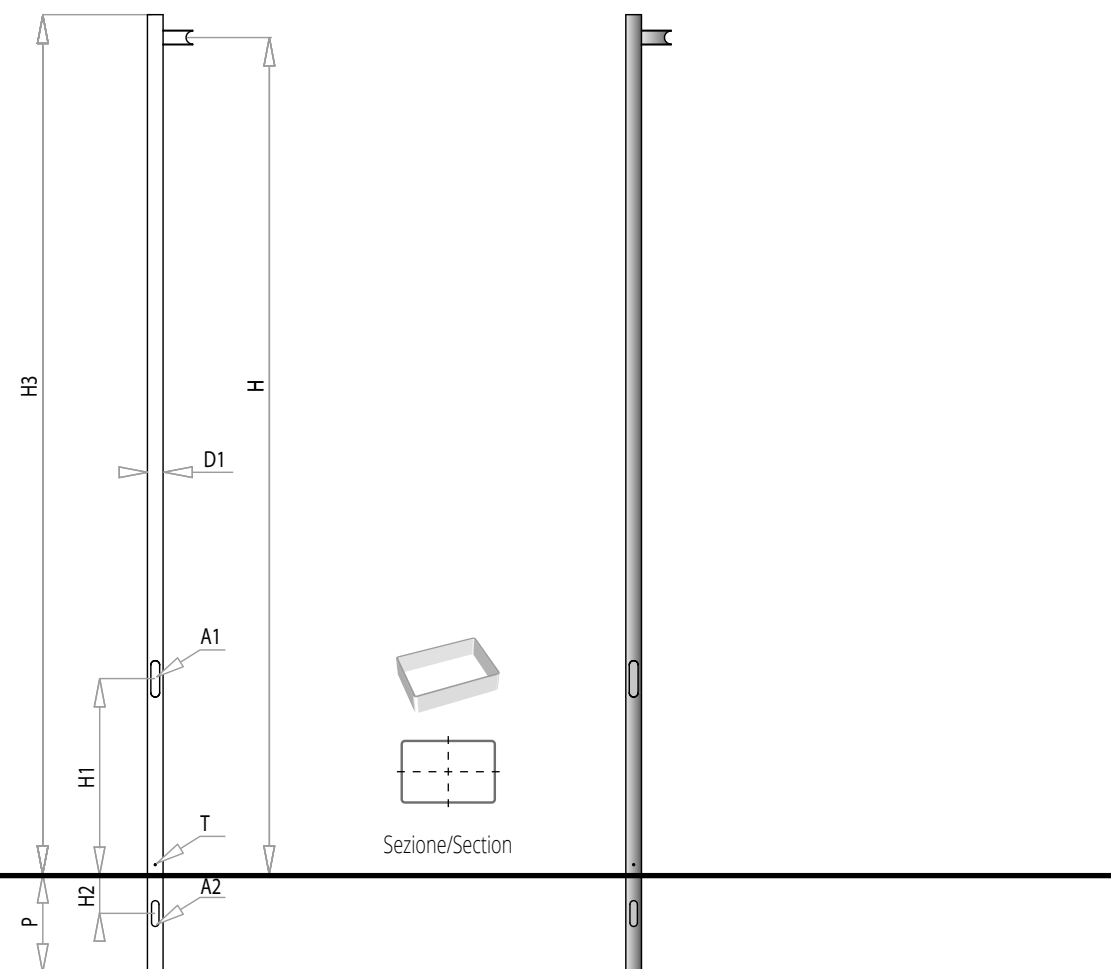

H altezze punto luce
available luminaire heights

PR

SISTEMA LOGIKA - Q QUADRO | LOGIKA AND Q QUADRO SYSTEM

Palo in acciaio a sezione rettangolare realizzato in un unico tratto. Il palo è dotato di braccio in alluminio trafilato per l'installazione di apparecchi della serie Q Quadro. Asola ingresso cavi e asola per morsettiera con finitura dei bordi del taglio idonea anche per l'applicazione di portella incassata a filo palo. Zincatura a caldo secondo la norma ISO 1461 e successiva spazzolatura per garantire una perfetta finitura superficiale. Verniciatura a polveri poliestere. Cod. 01,02,03,04, RAL su richiesta.

Rectangular cross section steel pole consisting of one single section. The pole is fitted with a drawn aluminium bracket for the installation of units of the Q Quadro range. Cable inlet slot and terminal box slot with finished edges, also suitable for the application of a flush mounted cover door. Hot galvanized in accordance with ISO 1461, and subsequent brushing to ensure perfect surface finish. Polyester powder coating. Code 01,02,03,04, RAL on request.



COMPOSIZIONI COMPOSITIONS

COMPOSIZIONE BRACCI LOGIKA 1 (L1) / LOGIKA 2 (L2) LOGIKA 1 (L1) / LOGIKA 2 (L2) BRACKET COMPOSITION

	PR 4	PR 5
▪	PR 4 / 1 / L1 PR 4 / 1 / L2	PR 5 / 1 / L1 PR 5 / 1 / L2
▪▪	PR 4 / 2 / L1 PR 4 / 2 / L2	PR 5 / 2 / L1 PR 5 / 2 / L2

COMPOSIZIONE BRACCI Q3 QUADRO (Q3) / Q5 QUADRO (Q5) Q3 QUADRO (Q3) / Q5 QUADRO (Q5) BRACKET COMPOSITION

	PR 4	PR 5
▪	PR 4 / 1 / Q3 PR 4 / 1 / Q5	PR 5 / 1 / Q3 PR 5 / 1 / Q5
▪▪	PR 4 / 2 / Q3 PR 4 / 2 / Q5	PR 5 / 2 / Q3 PR 5 / 2 / Q5

- Composizione a 1 braccio - 1 bracket mounting
- Composizione a 2 bracci - 2 brackets mounting



Palo serie PL versione speciale con fissaggio inclinato.
PL pole series in a bended mounted special version.

ACCESSORI ACCESSORIES

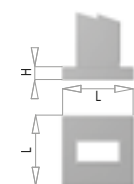

BASE BR

LxL	260x260
H	160



PORTELLA CON MORSETTIERA TERMINAL BLOCK WITH HATCH

	Standard Standard
PR 4	T-39 Q
PR 5	T-39

Disponibili a 1 o 2 fusibili - Available with 1 or 2 fuses

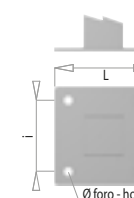

PIASTRA - PLATE

	i	LxL	Ø Foro Hole Ø	Spessore Thickness
PR 4	180	250x250	22	10
PR 5	180	250x250	22	10

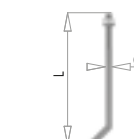

KIT TIRAFONDI - ANCHOR BOLTS

L	500
Ø	M 18

Valori espressi in millimetri | Measures in millimeters

PR

SISTEMA LOGIKA - Q QUADRO | LOGIKA AND Q QUADRO SYSTEM

			PR 4	PR 5
DIMENSIONI DIMENSIONS	D1	Tratto unico (L x L x spessore) Single section (S x S x thickness)	160x80x3 mm	160x80x3 mm
MATERIALI MATERIALS		Tratto unico Single section	S235 JR	S235 JR
LAVORAZIONI FINISHING	A1	Asola morsettiera Terminal block hole	186x45 mm	186x45 mm
	A2	Asola ingresso cavi Cable slot	132x38 mm	132x38 mm
	T	Messa a terra Grounding	Inserito filettato M10, zincato - M10 threaded, galvanized insert	
ALTEZZA HEIGHT	H	Altezza punto luce Luminaire height	3900 mm	4900 mm
	H1	Altezza portella Hatch height	1000 mm	1000 mm
	H2	Asola passaggio cavi Cable slot height	200 mm	200 mm
	H3	Altezza fuori terra Above ground height	4000 mm	5000 mm
INTERRAMENTO IN-GROUNDING	P		500 mm	500 mm
PESO WEIGHT			50 kg	63 kg

La scelta del palo è soggetta a verifica strutturale effettuata in base alla zona di installazione. AEC procede al dimensionamento e alla verifica della resistenza del sostegno secondo la normativa EN-40.

The pole must be chosen after a structural pole test depending on the area of installation. AEC verifies the dimensioning and the resistance of the column according to the EN-40 standard.

10

9

8

7

6

5

4

3

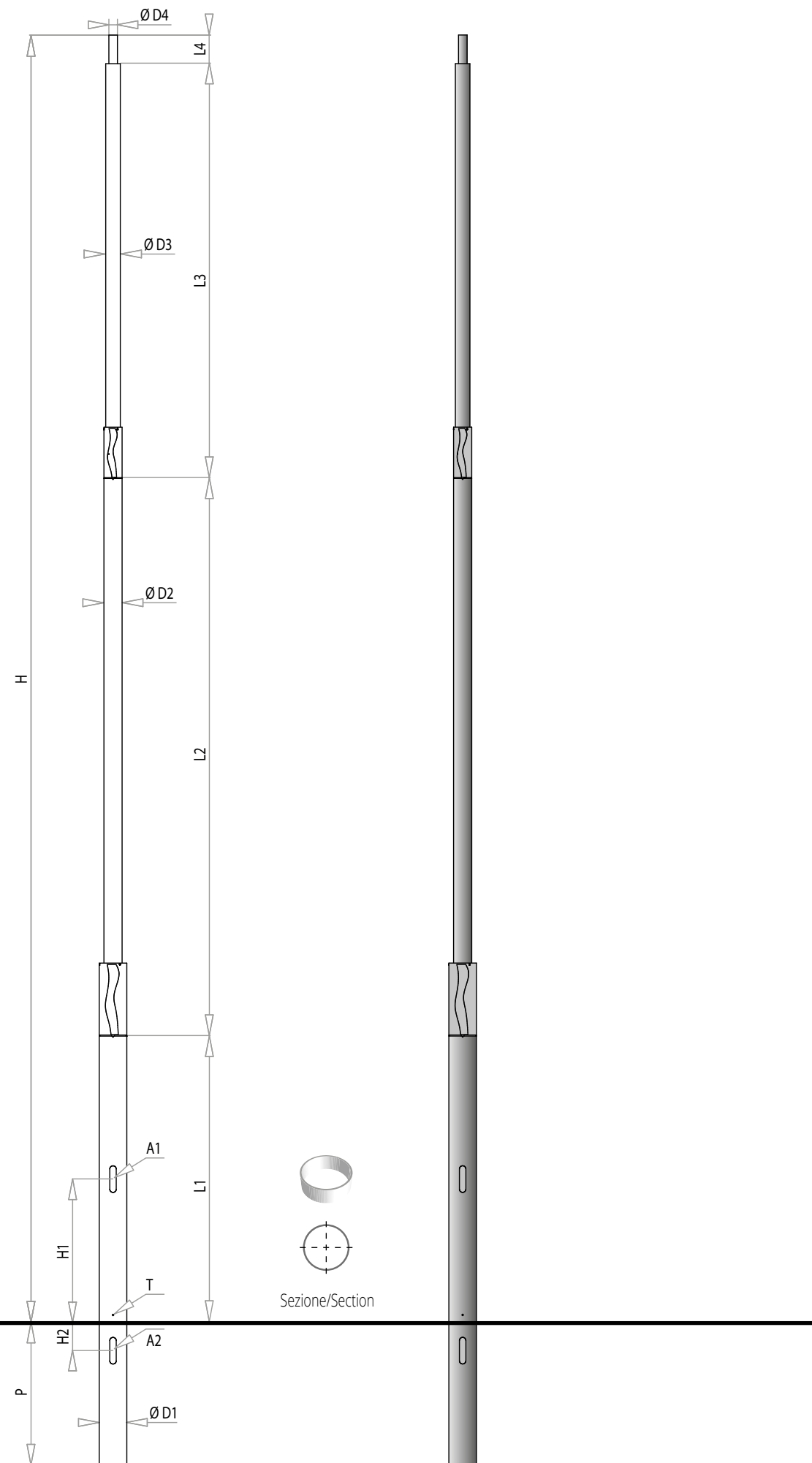

H altezze punto luce
available luminaire heights

Valori espressi in metri | Measures in metres

PD

SISTEMA DELOS | DELOS SYSTEM

Modello depositato | Registered model

Palo in acciaio a sezione circolare rastremato con rondella piatta, composto da due tratti (solo versione PD 5) e tre tratti con codolo finale, realizzato con elementi tubolari saldati in sequenza. Il palo è dotato di decori e di una basetta ornamentale realizzati in fusione di ghisa EN-GJL-200 EN 1561. Asola ingresso cavi e asola per morsettiera con finitura dei bordi del taglio idonea anche per l'applicazione di portella incassata. I pali della serie PD fanno parte del sistema DELOS che comprende i corpi illuminanti Delos 1 e Delos 2 con i bracci MPD/C ed MPD/L in versione testa palo o sfalsato. Zincatura a caldo secondo la norma ISO 1461 e successiva spazzolatura per garantire una perfetta finitura superficiale. Verniciatura a polveri poliestere. Cod. 01, RAL su richiesta.

Circular cross section tapered steel pole with flat steel washer, consisting of two sections (PD 5 version only) or three sections and end spigot, made of tubular elements welded in sequence. The pole is fitted with trims and an ornamental base made of cast iron EN-GJL-200 EN 1561. Cable inlet slot and terminal box slot with finished edges, also suitable for the application of a flush mounted cover door. The poles of the PD range are part of the DELOS system, which includes Delos 1 and Delos 2 lighting bodies, with MPD/C and MPD/L brackets, available in the pole head, or the staggered versions.

Hot galvanized in accordance with ISO 1461, and subsequent brushing to ensure perfect surface finish. Polyester powder coating.

Code 01, RAL on request.



COMPOSIZIONI COMPOSITIONS

ACCESSORI ACCESSORIES

PD

SISTEMA DELOS | DELOS SYSTEM

Modello depositato | Registered model

COMPOSIZIONE BRACCI DELOS - TABELLA 1
DELOS BRACKET COMPOSITION - TABLE 1

	PD 5	PD 6	PD 7	PD 8	PD 9	PD 10
■	MPD/C_1 MPD/L_1	MPD/C_1 MPD/L_1	MPD/C_1 MPD/L_1	MPD/C_1 MPD/L_1	MPD/C_1 MPD/L_1	MPD/C_1 MPD/L_1
■ ■	MPD/C_2 MPD/L_2	MPD/C_2 MPD/L_2	MPD/C_2 MPD/L_2	MPD/C_2 MPD/L_2	MPD/C_2 MPD/L_2	MPD/C_2 MPD/L_2
■ ■ ■	MPD/C_3 MPD/L_3	MPD/C_3 MPD/L_3	MPD/C_3 MPD/L_3	MPD/C_3 MPD/L_3	MPD/C_3 MPD/L_3	MPD/C_3 MPD/L_3
■ ■ ■ ■	MPD/C_4 MPD/L_4	MPD/C_4 MPD/L_4	MPD/C_4 MPD/L_4	MPD/C_4 MPD/L_4	MPD/C_4 MPD/L_4	MPD/C_4 MPD/L_4

COMPOSIZIONE BRACCI SFALSATI DELOS - TABELLA 2
DELOS STAGGERED BRACKET COMPOSITION - TABLE 2

	PD 5	PD 6	PD 7	PD 8	PD 9	PD 10
■		MSPD/C_1 MSPD/L_1	MSPD/C_1 MSPD/L_1	MSPD/C_1 MSPD/L_1	MSPD/C_1 MSPD/L_1	MSPD/C_1 MSPD/L_1

- Composizione a 1 braccio - 1 bracket mounting
- ■ Composizione a 2 bracci - 2 brackets mounting
- ■ ■ Composizione a 3 bracci - 3 brackets mounting
- ■ ■ ■ Composizione a 4 bracci - 4 brackets mounting

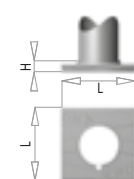

BASE BD

	LxL	H
PD 5	310x310	51
PD 6	310x310	51
PD 7	310x310	51
PD 8	360x360	55
PD 9	360x360	55
PD 10	360x360	55

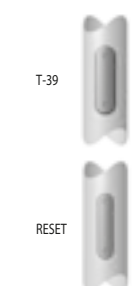

PORTELLA CON MORSETTIERA TERMINAL BLOCK WITH HATCH

	Standard Standard	Filo palo Flush mounted
PD 5	T-39 G	RESET 18
PD 6	T-39 G	RESET 18
PD 7	T-39 G	RESET 18
PD 8	T-39 G	RESET OD 18
PD 9	T-39 G	RESET OD 18
PD 10	T-39 G	RESET OD 18

Disponibili a 1 o 2 fusibili - Available with 1 or 2 fuses

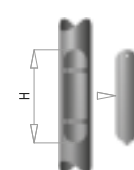

ASOLA MAXI - MAXI TERMINAL BLOCK HOLE

HxL	
	300x85
	400x90

Previa verifica strutturale - Structural verification required
Altre su richiesta - Others upon request

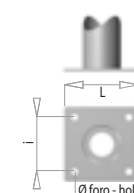

PIASTRA - PLATE

	i	LxL	Ø Foro Hole Ø	Spessore Thickness
PD 5	230	300x300	22	15
PD 6	230	300x300	22	15
PD 7	230	300x300	22	15
PD 8	260	350x350	30	20
PD 9	260	350x350	30	20
PD 10	260	350x350	30	20

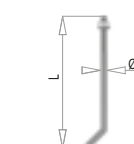

KIT TIRAFONDI - ANCHOR BOLTS

	PD 5 - PD 6 - PD 7	PD 8 - PD 9 - PD 10
L	500	700
Ø	M 18	M 27

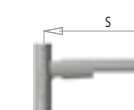

BRACCIO - BRACKET

	MPD/C	MPD/L
S	750	1000

Per composizioni su bracci e bracci sfalsati vedere
tabelle pag. 69 - For installation on brackets and staggered
brackets see tables pag. 69

Valori espressi in millimetri | Measures in millimeters

			PD 5	PD 6	PD 7	PD 8	PD 9	PD 10	
DIMENSIONI DIMENSIONS	D1	1° Tratto (Ø x spessore) 1 st Section (Ø x thickness)	159x3 mm	159x3 mm	159x3 mm	193x3 mm	193x3 mm	193x3 mm	
	L1	Lunghezza 1° Tratto 1 st Section length	1100 mm	1100 mm	1700 mm	1700 mm	2000 mm	2000 mm	
	D2	2° Tratto (Ø x spessore) 2 nd Section (Ø x thickness)	102x3 mm	127x3 mm	127x3 mm	127x3 mm	127x3 mm	127x3 mm	
	L2	Lunghezza 2° Tratto 2 nd Section length	3900 mm	2900 mm	2900 mm	3900 mm	3900 mm	4900 mm	
	D3	3° Tratto (Ø x spessore) 3 rd Section (Ø x thickness)	-	102x3 mm	102x3 mm	102x3 mm	102x3 mm	102x3 mm	
	L3	Lunghezza 3° Tratto 3 rd Section length	-	1900 mm	2400 mm	2400 mm	2900 mm	2900 mm	
	D4	Ø Codolo - Ø Spigot	60x3 mm	60x3 mm	60x3 mm	60x3 mm	60x3 mm	60x3 mm	
	L4	Lunghezza Codolo Spigot length	200 mm	200 mm	200 mm	200 mm	200 mm	200 mm	
	MATERIALI MATERIALS	D1	1° Tratto - 1 st Section	S235 JR	S235 JR	S235 JR	S235 JR	S235 JR	S235 JR
		D2	2° Tratto - 2 nd Section	S235 JR	S235 JR	S235 JR	S235 JR	S235 JR	S235 JR
D3		3° Tratto - 3 rd Section	S235 JR	S235 JR	S235 JR	S235 JR	S235 JR	S235 JR	
D4		Codolo - Spigot	S235 JR	S235 JR	S235 JR	S235 JR	S235 JR	S235 JR	
LAVORAZIONI FINISHING	A1	Asola morsettiere Terminal block hole	186x45 mm	186x45 mm	186x45 mm	186x45 mm	186x45 mm	186x45 mm	
	A2	Asola ingresso cavi Cable slot	186x45 mm	186x45 mm	186x45 mm	186x45 mm	186x45 mm	186x45 mm	
	T	Messa a terra Grounding	Insero filettato M10, zincato - M10 threaded, galvanized insert						
ALTEZZA HEIGHT	H	Altezza punto luce Luminaire height	5200 mm	6100 mm	7200 mm	8200 mm	9000 mm	10000 mm	
	H1	Altezza portella Hatch height	800 mm	800 mm	800 mm	1000 mm	1000 mm	1000 mm	
	H2	Asola passaggio cavi Cable slot height	200 mm	200 mm	200 mm	200 mm	200 mm	200 mm	
	H3	Altezza punto luce intermedio opzionale Middle luminaire installation height (optional)	-	4200 mm	4800 mm	5800 mm	6100 mm	7100 mm	
INTERRAMENTO IN-GROUNDING	P		800 mm	800 mm	800 mm	800 mm	1000 mm	1000 mm	
PESO WEIGHT			53 kg	66 kg	77 kg	93 kg	103 kg	112 kg	

La scelta del palo è soggetta a verifica strutturale effettuata in base alla zona di installazione. AEC procede al dimensionamento e alla verifica della resistenza del sostegno secondo la normativa EN-40.

The pole must be chosen after a structural pole test depending on the area of installation. AEC verifies the dimensioning and the resistance of the column according to the EN-40 standard.



10

9

8

7

6

5

4

3

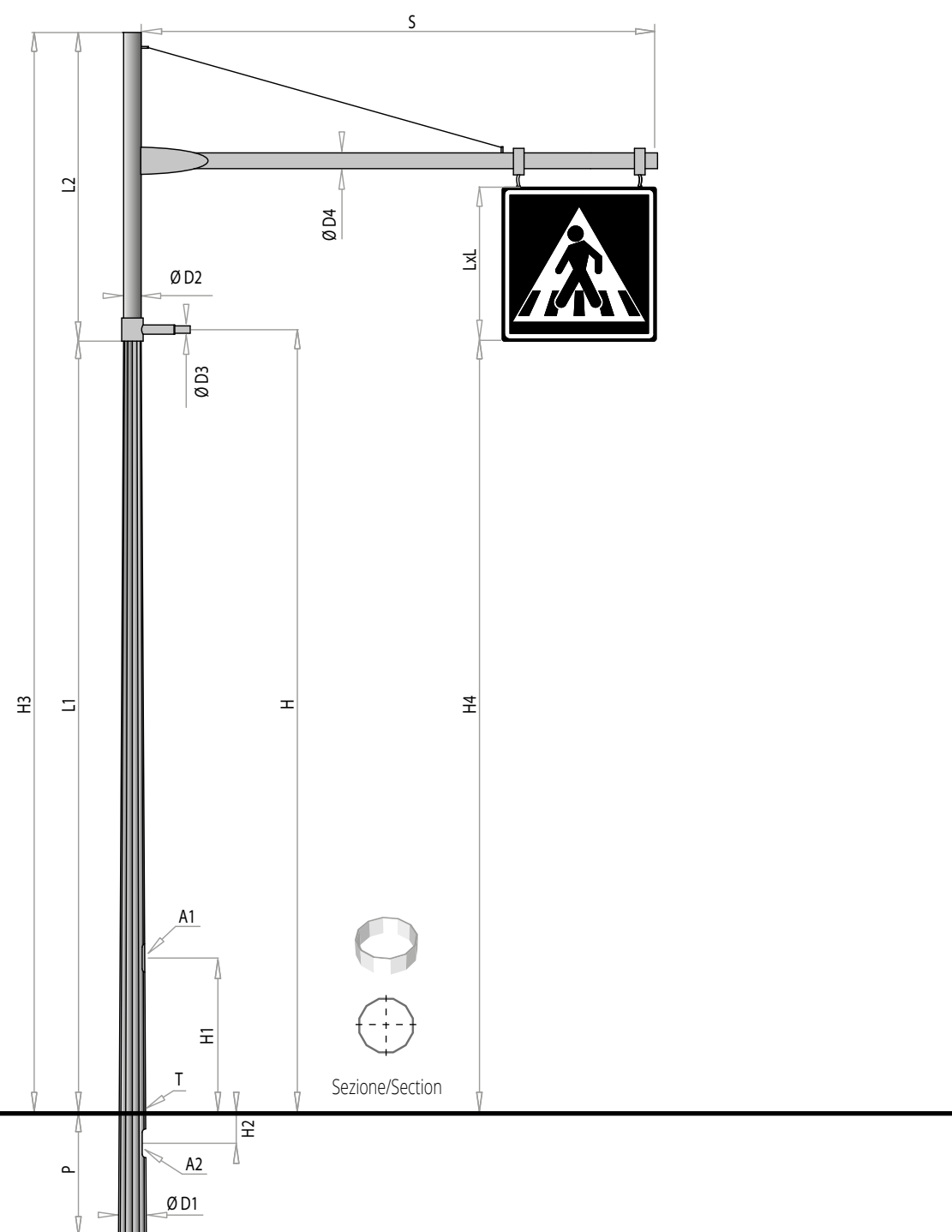

H altezze punto luce
available luminaire heights

Sostegno formato da 2 tronchi incastrati e saldati in sequenza. Primo tratto a sezione poligonale a 12 lati, secondo tratto a sezione circolare. Nel punto di unione tra le 2 diverse sezioni è saldato un codolo in acciaio a sezione circolare con codolo per installazione di apparecchi di illuminazione con attacco $\varnothing 60\text{mm}$. Braccio porta-segnaletica in acciaio a sezione circolare disponibile in due lunghezze. Il punto di innesto del braccio è munito di 2 lame di acciaio aventi funzione decorativa e di rinforzo del supporto. Il braccio è dotato di cartello luminoso bifacciale serigrafato, installabile attraverso appositi collari di fissaggio. Cavo tirante in acciaio inox $\varnothing 6\text{ mm}$ fissato nella parte superiore del palo. Zincatura a caldo secondo la norma ISO 1461 e successiva spazzolatura per garantire una perfetta finitura superficiale. Cod. 01, 02, 03, 04, RAL su richiesta.

Support consisting of 2 sections welded in sequence. First part featured by 12 sides polygonal section. Second part featured by circular section. Circular steel spigot for the installation of luminaires with $\varnothing 60\text{ mm}$ attack welded in the junction between the 2 different sections. Steel circular section bracket for signposting provided in two lengths.

The junction point of the arm is equipped with 2 blades in steel having a decorative function and reinforcing the support. The bracket comes with a luminous double sided printed sign, installed by means of a special fastening system. Cable tie in stainless steel $\varnothing 6\text{ mm}$ fixed at the top of the pole. Hot galvanized in accordance with ISO 1461, and subsequent brushing to ensure perfect surface finish. Code 01, 02, 03, 04, RAL on request.



ACCESSORI ACCESSORIES

AP

SERIE SICUREZZA | SAFETY SERIES



PORTELLA CON MORSETTIERA TERMINAL BLOCK WITH HATCH

	Standard Standard
AP/7/3 3500	T-39 GG2
AP/7/7 3500	T-39 GG2
AP/7/9 3500	T-39 GG2
AP/7/3 4000	T-39 GG2
AP/7/7 4000	T-39 GG2
AP/7/9 4000	T-39 GG2

Disponibili a 1 o 2 fusibili - Available with 1 or 2 fuses

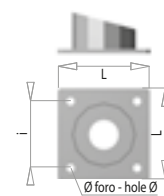

PIASTRA - PLATE

	i	LxL	Ø Foro Hole Ø	Spessore Thickness
AP/7/3 3500	250	350x350	30	25
AP/7/7 3500	250	350x350	30	25
AP/7/9 3500	250	350x350	30	25
AP/7/3 4000	250	350x350	30	25
AP/7/7 4000	250	350x350	30	25
AP/7/9 4000	250	350x350	30	25

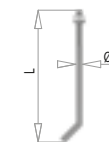

KIT TIRAFONDI - ANCHOR BOLTS

	L	Ø
AP/7/3 3500	500	M 24
AP/7/7 3500	500	M 24
AP/7/9 3500	500	M 24
AP/7/3 4000	500	M 24
AP/7/7 4000	500	M 24
AP/7/9 4000	500	M 24

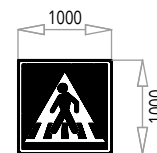

Cartello bifacciale luminoso | Double side illuminated sign

Valori espressi in millimetri | Measures in millimeters

		AP/7/3 3500	AP/7/7 3500 ¹	AP/7/9 3500 ²	AP/7/3 4000	AP/7/7 4000 ¹	AP/7/9 4000 ²
DIMENSIONI DIMENSIONS	Massimo vento di riferimento Max reference wind speed	27m/s	29m/s	31m/s	27m/s	29m/s	31m/s
	D1 1° Tratto (Ø x spessore) 1 st Section (Ø x thickness)	180x4 mm	180x4 mm	180x5 mm	180x4 mm	180x4 mm	180x5 mm
	L1 Lunghezza 1° Tratto 1 st Section length	5200 mm	5200 mm	5200 mm	5200 mm	5200 mm	5200 mm
	D2 2° Tratto (Ø x spessore) 2 nd Section (Ø x thickness)	114x5 mm	114x5 mm	114x5 mm	114x5 mm	114x5 mm	114x5 mm
	L2 Lunghezza 2° Tratto 2 nd Section length	2000 mm	2000 mm	2000 mm	2000 mm	2000 mm	2000 mm
	D3 Ø Codolo - Ø Spigot	Ø60 mm	Ø60 mm	Ø60 mm	Ø60 mm	Ø60 mm	Ø60 mm
	D4 Ø Braccio - Ø Bracket	102x3 mm	102x4 mm	102x4 mm	102x3 mm	102x4 mm	102x4 mm
	S Ø Braccio - Ø Bracket	3500 mm	3500 mm	3500 mm	4000 mm	4000 mm	4000 mm
	MATERIALI MATERIALS	D1 1° Tratto - 1 st Section	S355 JR	S355 JR	S355 JR	S355 JR	S355 JR
	D2 2° Tratto - 2 nd Section	S235 JR	S235 JR	S235 JR	S235 JR	S235 JR	S235 JR
LAVORAZIONI FINISHING	A1 Asola morsettiere Terminal block hole	186x45 mm	186x45 mm	186x45 mm	186x45 mm	186x45 mm	186x45 mm
	A2 Asola ingresso cavi Cable slot	186x45 mm	186x45 mm	186x45 mm	186x45 mm	186x45 mm	186x45 mm
	T Messa a terra - Grounding	Inserto filettato M10, zincato - M10 threaded, galvanized insert					
ALTEZZA HEIGHT	H Altezza punto luce Luminaire height	5275 mm	5275 mm	5275 mm	5275 mm	5275 mm	5275 mm
	H1 Altezza portella Hatch height	1000 mm	1000 mm	1000 mm	1000 mm	1000 mm	1000 mm
	H2 Asola passaggio cavi Cable slot height	200 mm	200 mm	200 mm	200 mm	200 mm	200 mm
	H3 Altezza fuori terra Above ground height	7200 mm	7200 mm	7200 mm	7200 mm	7200 mm	7200 mm
	H4 Altezza cartello Poster height	5200 mm	5200 mm	5200 mm	5200 mm	5200 mm	5200 mm
INTERRAMENTO IN-GROUNDING	P	800 mm	800 mm	800 mm	800 mm	800 mm	800 mm
PESO WEIGHT	Escluso cartello Sign excluded	135 Kg Mensola - Bracket 26 Kg	135 Kg Mensola - Bracket 35 Kg	155 Kg Mensola - Bracket 35 Kg	135 Kg Mensola - Bracket 30 Kg	140 Kg Mensola - Bracket 39 Kg	155 Kg Mensola - Bracket 39 Kg

¹ Versioni con uno spessore maggiore per il braccio.² Versioni con uno spessore maggiore per il braccio e palo.

La scelta del palo è soggetta a verifica strutturale effettuata in base alla zona di installazione. AEC procede al dimensionamento e alla verifica della resistenza del sostegno secondo la normativa EN-40.

¹ Versions feature a thicker bracket.² Versions feature a thicker bracket and pole.

The pole must be chosen after a structural pole test depending on the area of installation. AEC verifies the dimensioning and the resistance of the column according to the EN-40 standard.

10

9

8

7

6

5

4

3

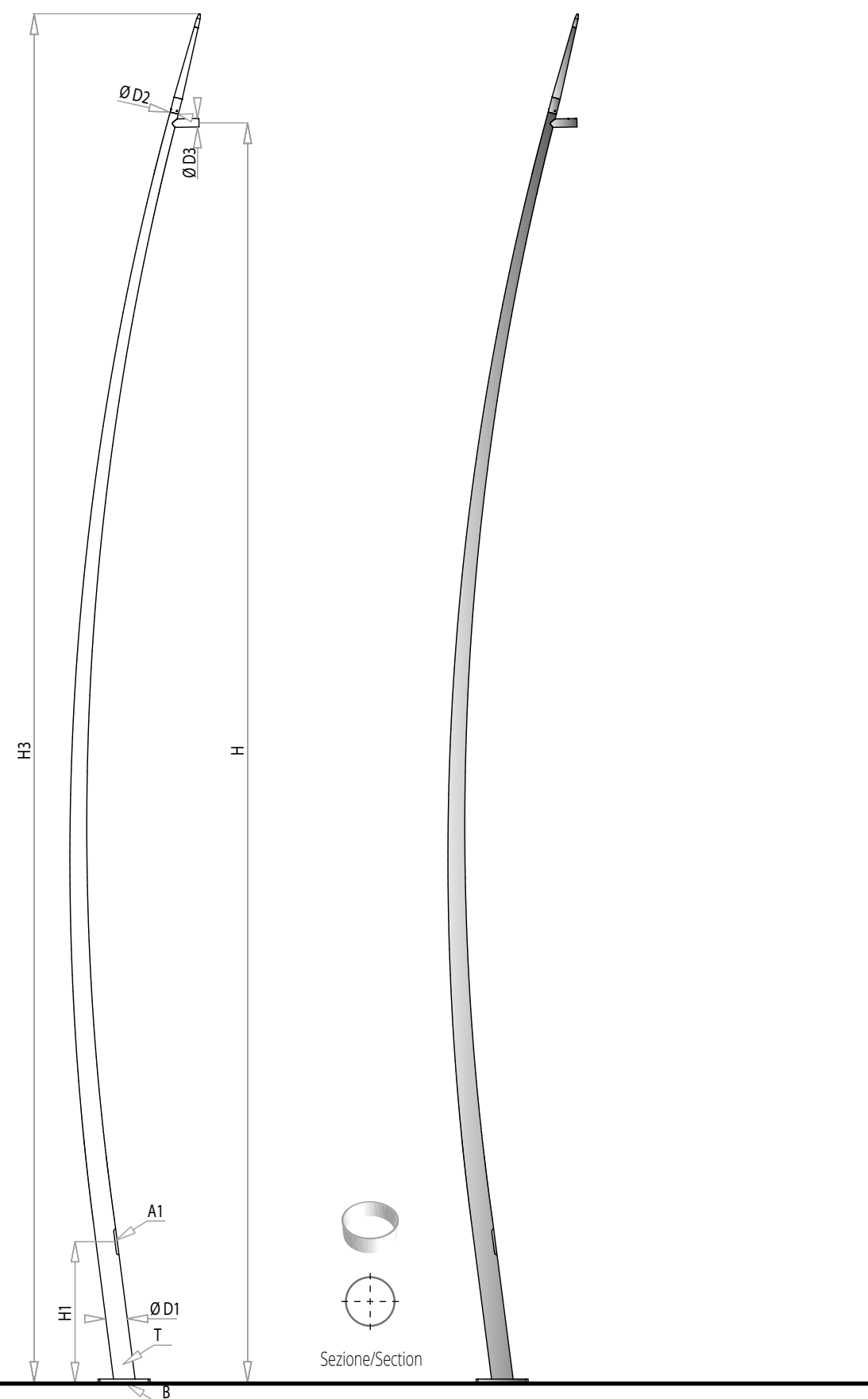

Valori espressi in metri | Measures in metres

H altezze punto luce
available luminaire heights

PF

Design series | Designed by
Marzia Bandini - Massimo Sacconi

Palo conico in acciaio saldato e scordonato, realizzato in un unico tratto piegato longitudinalmente. Puntale conico in alluminio trafilato con finale in materiale plastico. Il palo è dotato di codolo standard per l'installazione di apparecchi della serie Logika compatibili con la serie PF. Fissaggio con piastra di base. Asola per morsettiera con finitura dei bordi del taglio idonea anche per l'applicazione di portella incassata a filo palo. Zincatura a caldo secondo la norma ISO 1461 e successiva spazzolatura per garantire una perfetta finitura superficiale. Verniciatura a polveri poliestere.
Cod. 01,02,03,04, RAL su richiesta.

Conical steel pole, welded and de-beaded, consisting of one single longitudinally bent section. Conical drawn aluminium tip with plastic end. The pole has a standard spigot for the installation of Logika Range units compatible with the PF range. Fastening base plate. Terminal box slot with finished edges, also suitable for the application of a flush mounted cover. Hot galvanized in accordance with ISO 1461, and subsequent brushing to ensure perfect surface finish. Polyester powder coating. Code 01, RAL on request.



ACCESSORI ACCESSORIES

PF

Design series | *Designed by*

Marzia Bandini - Massimo Sacconi

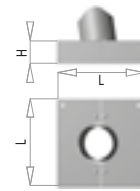

BASE BF

	LxL	H
PF 5	270x270	85
PF 6	270x270	85
PF 7	320x320	85
PF 8	320x320	85
PF 9	370x370	85
PF 10	370x370	85



PORTELLA CON MORSETTIERA TERMINAL BLOCK WITH HATCH

	Standard Standard	Filo palo Flush mounted
PF 5	T-39	RESET 12
PF 6	T-39	RESET 15
PF 7	T-39 G	RESET 16
PF 8	T-39 G	RESET 17
PF 9	T-39 G	RESET 18
PF 10	T-39 G	RESET 18

Disponibili a 1 o 2 fusibili - Available with 1 or 2 fuses

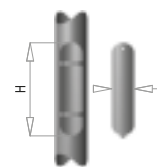

ASOLA MAXI - MAXI TERMINAL BLOCK HOLE

HxL	
	300x65
	400x90*

Previa verifica strutturale - Structural verification required
Altre su richiesta - Others upon request
* Escluso PF 5, PF 6, PF 7 - Except PF 5, PF 6, PF 7

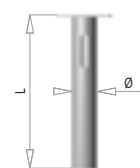

CONTROPIASTRA INTERRAMENTO IN-GROUNDING PLATE

L	850
Ø	139

	PF 5 - PF 6	PF 7 - PF 8	PF 9 - PF 10
LxL	250x250	300x300	350x350

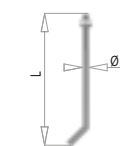

KIT TIRAFONDI - ANCHOR BOLTS

	PF 5 - PF 6 - PF 7 - PF 8	PF 9 - PF 10
L	500	700
Ø	M 18	M 20

Valori espressi in millimetri | Measures in millimeters

		PF 5	PF 6	PF 7	PF 8	PF 9	PF 10		
DIMENSIONI DIMENSIONS	D1	Dimensione alla base (Ø x spessore) Dimension at the base (Ø x thickness)		110x3 mm	121x3 mm	130x3 mm	141x3 mm	151x3 mm	161x3 mm
	D2	Dimensione in testa (Ø) Dimension at the top (Ø)		60 mm	60 mm	60 mm	60 mm	60 mm	60 mm
	D3	Codolo (Ø) Spigot (Ø)		48 mm	48 mm	60 mm	60 mm	60 mm	60 mm
MATERIALI MATERIALS	D1	Tratto unico Single section		S235 JR	S235 JR	S235 JR	S235 JR	S235 JR	S235 JR
	A1	Asola morsettiera Terminal block hole		186x45 mm	186x45 mm	186x45 mm	186x45 mm	186x45 mm	186x45 mm
LAVORAZIONI FINISHING	B	Piastra di base Base plate	Dimensione (LxL) Dimension (LxL)	250x250 mm	250x250 mm	300x300 mm	300x300 mm	350x350 mm	350x350 mm
			Interasse (i) Spacing (i)	148 mm	148 mm	158 mm	158 mm	230 mm	230 mm
			Ø foro Hole Ø	22 mm	22 mm	22 mm	22 mm	24 mm	24 mm
			Spessore Thickness	12 mm	12 mm	12 mm	15 mm	15 mm	15 mm
T	Messa a terra Grounding		Insero filettato M10, zincato - M10 threaded, galvanized insert						
ALTEZZA HEIGHT	H	Altezza punto luce Luminaire height		5000 mm	6000 mm	7000 mm	8000 mm	9000 mm	10000 mm
	H1	Altezza portella Hatch height		1000 mm	1000 mm	1000 mm	1000 mm	1000 mm	1000 mm
	H3	Altezza fuori terra Above ground height		5745 mm	6745 mm	7745 mm	8730 mm	9740 mm	10715 mm
PESO WEIGHT			37 kg	46 kg	55 kg	66 kg	78 kg	100 kg	

La scelta del palo è soggetta a verifica strutturale effettuata in base alla zona di installazione. AEC procede al dimensionamento e alla verifica della resistenza del sostegno secondo la normativa EN-40.

The pole must be chosen after a structural pole test depending on the area of installation. AEC verifies the dimensioning and the resistance of the column according to the EN-40 standard.



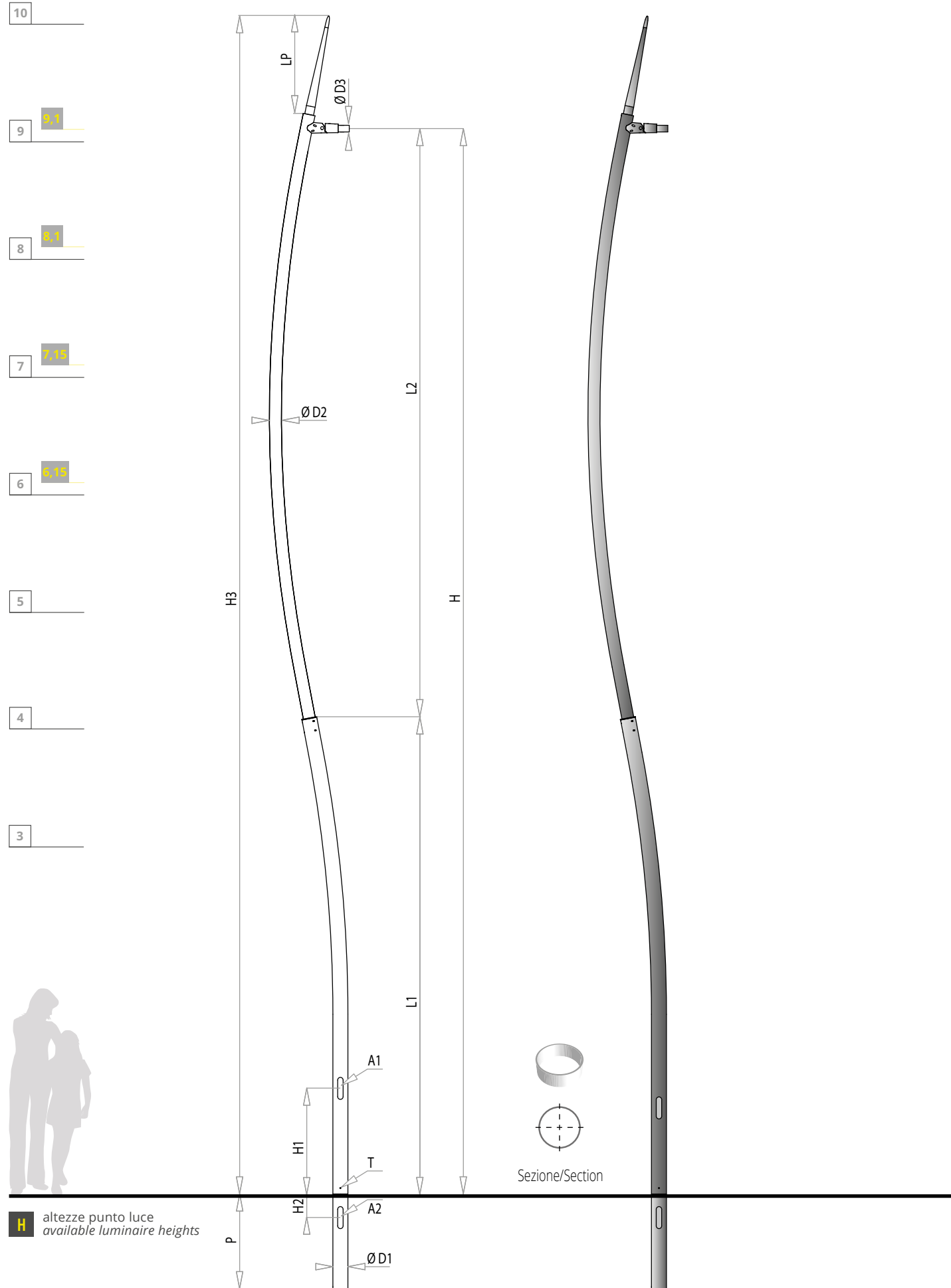

H altezze punto luce
available luminaire heights

Valori espressi in metri | Measures in metres

Palo in acciaio a sezione circolare rastremato, composto da due tratti curvati a raggio contrapposto realizzati con elementi tubolari saldati in sequenza. Il palo è dotato di codolo laterale per il montaggio di corpi illuminanti, contraddistinto da un elemento in fusione di alluminio dotato di sistema ad inclinazione regolabile rispetto al piano stradale. Il codolo standard è idoneo per apparecchi predisposti di attacco Ø 60 mm. Parte finale con puntale in acciaio conificato. Asola ingresso cavi e asola per morsettiera con finitura dei bordi del taglio idonea anche per l'applicazione di portella incassata. Zincatura a caldo secondo la norma ISO 1461 e successiva spazzolatura per garantire una perfetta finitura superficiale. Verniciatura a polveri poliestere. Cod. 01,02,03,04, RAL su richiesta.

Circular cross section tapered steel pole consisting of two sections with opposite radius bends, made of tubular elements welded in sequence. The pole has a side spigot for the installation of lighting bodies, featuring a cast aluminium element with a tilting system that can be adjusted based on the road level. The standard spigot is suitable for units with Ø 60 mm connections. End part with conical steel tip. Cable inlet slot and terminal box slot with finished edges, also suitable for the application of a flush mounted cover door. Hot galvanized in accordance with ISO 1461, and subsequent brushing to ensure perfect surface finish. Polyester powder coating. Code 01,02,03,04, RAL on request.



ACCESSORI ACCESSORIES

PS

Design series | *Designed by*

Marzia Bandini - Massimo Sacconi

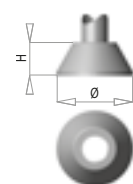

BASE BA/2

H	160
Ø	360

PORTELLA CON MORSETTIERA
TERMINAL BLOCK WITH HATCH

	Standard Standard	Filo palo Flush mounted
PS 6	T-39 G	RESET 16
PS 7	T-39 G	RESET 16
PS 8	T-39 G	RESET 16
PS 9	T-39 G	RESET 16

Disponibili a 1 o 2 fusibili - Available with 1 or 2 fuses

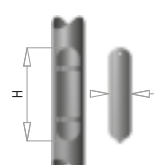

ASOLA MAXI - MAXI TERMINAL BLOCK HOLE

HxL	300x65
	400x90

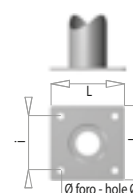
Previa verifica strutturale - Structural verification required
Altre su richiesta - Others upon request

PIASTRA - PLATE

	i	LxL	Ø Foro Hole Ø	Spessore Thickness
PS 6	180	250x250	22	15
PS 7	180	250x250	22	15
PS 8	260	350x350	30	20
PS 9	260	350x350	30	20

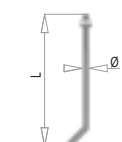

KIT TIRAFONDI - ANCHOR BOLTS

	PS 6 - PS 7 - PS 8	PS 9 - PS 10
L	500	700
Ø	M 18	M 27

Valori espressi in millimetri | Measures in millimeters

		PS 6	PS 7	PS 8	PS 9	
DIMENSIONI DIMENSIONS	D1	1° Tratto (Ø x spessore) 1 st Section (Ø x thickness)	127x3 mm	127x3 mm	127x3 mm	Ø127x3 mm
	L1	Lunghezza 1° Tratto 1 st Section length	3530 mm	3530 mm	4012 mm	4012 mm
	D2	2° Tratto (Ø x spessore) 2 nd Section (Ø x thickness)	102x3 mm	102x3 mm	102x3 mm	102x3 mm
	L2	Lunghezza 2° Tratto 2 nd Section length	2770 mm	3715 mm	4220 mm	5200 mm
	D3	Ø Codolo Ø Spigot	Ø60 mm	Ø60 mm	Ø60 mm	Ø60 mm
	LP	Lunghezza Puntale End part length	850 mm	850 mm	850 mm	850 mm
MATERIALI MATERIALS	D1	1° Tratto - 1 st Section	S235 JR	S235 JR	S235 JR	S235 JR
	D2	2° Tratto - 2 nd Section	S235 JR	S235 JR	S235 JR	S235 JR
LAVORAZIONI FINISHING	A1	Asola morsettiera Terminal block hole	186x45 mm	186x45 mm	186x45 mm	186x45 mm
	A2	Asola ingresso cavi Cable slot	186x45 mm	186x45 mm	186x45 mm	186x45 mm
	T	Messa a terra Grounding	Inserito filettato M10, zincato - M10 threaded, galvanized insert			
ALTEZZA HEIGHT	H	Altezza punto luce Luminaire height	6150 mm	7150 mm	8100 mm	9100 mm
	H1	Altezza portella Hatch height	800 mm	800 mm	1000 mm	1000 mm
	H2	Asola passaggio cavi Cable slot height	200 mm	200 mm	200 mm	200 mm
	H3	Altezza fuori terra Above ground height	7150 mm	8095 mm	9080 mm	10060 mm
INTERRAMENTO IN-GROUNDING	P		800 mm	800 mm	800 mm	800 mm
PESO WEIGHT			76 kg	80 kg	84 kg	88 kg

La scelta del palo è soggetta a verifica strutturale effettuata in base alla zona di installazione. AEC procede al dimensionamento e alla verifica della resistenza del sostegno secondo la normativa EN-40.

The pole must be chosen after a structural pole test depending on the area of installation. AEC verifies the dimensioning and the resistance of the column according to the EN-40 standard.

10

9

8

7

6

5

4

3

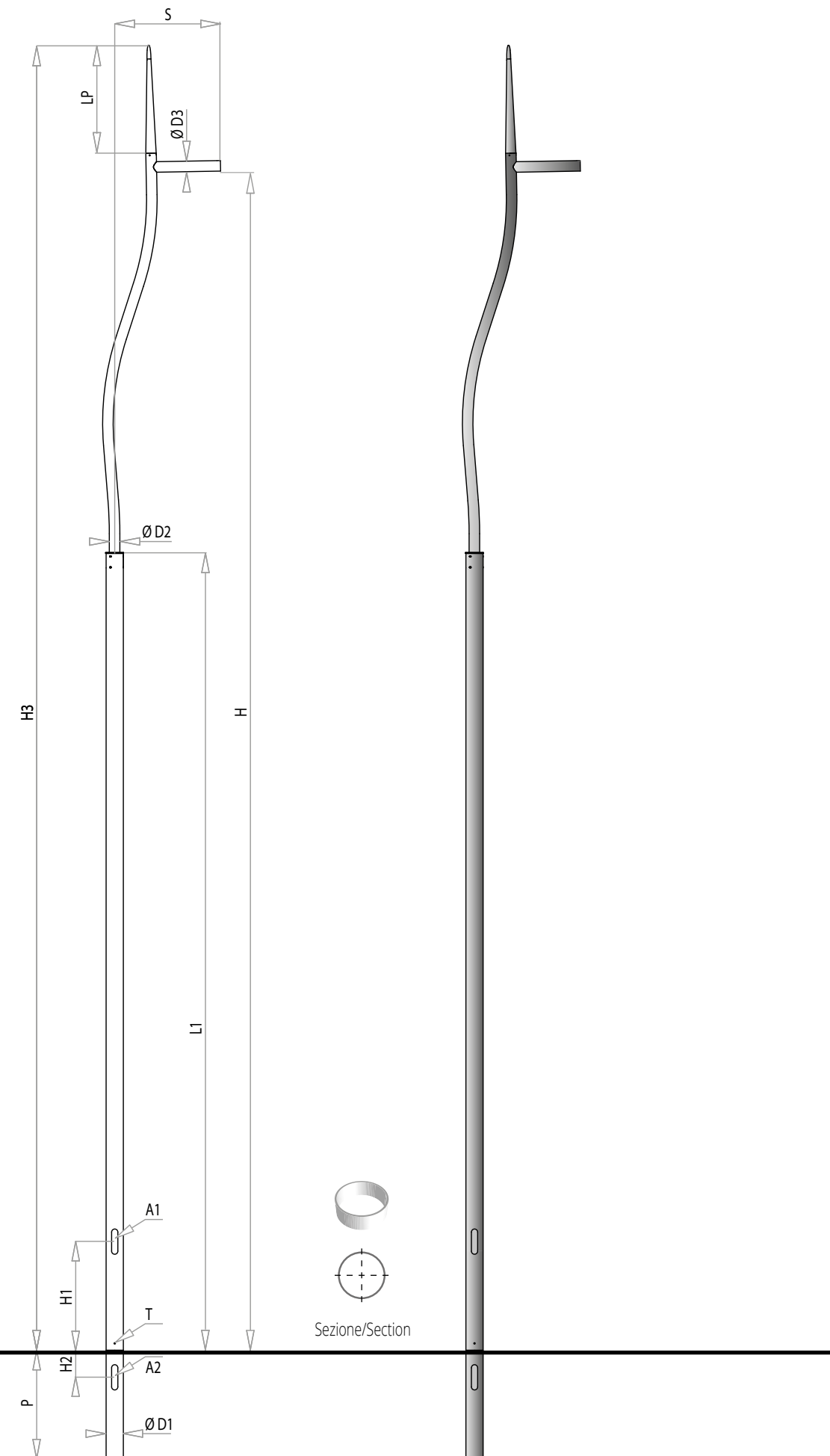

H altezze punto luce
available luminaire heights

PZ

Design series | Designed by

Marzia Bandini - Massimo Sacconi

Palo in acciaio composto da 2 elementi contraddistinti:

1. Prima parte: sezione tubolare circolare realizzata in un unico tratto.

2. Seconda parte (superiore): sezione tubolare circolare a profilo curvato.

La lavorazione di testa per il montaggio della parte superiore è realizzata con sistema a flangia interna con fissaggio tramite 6 viti laterali in acciaio inox. La parte superiore è realizzata in tubolare di acciaio sagomato a doppia curvatura differenziata contrapposta.

Parte finale con puntale in acciaio conificato. Codolo di attacco standard idoneo per apparecchi predisposti di attacco $\varnothing 76$ mm. Codolo adattatore disponibile per apparecchi con attacco $\varnothing 60$ mm (opzionale). Asola ingresso cavi e asola per morsettiera con finitura dei bordi del taglio idonea anche per l'applicazione di portella incassata a filo palo.

Zincatura a caldo secondo la norma ISO 1461 e successiva spazzolatura per garantire una perfetta finitura superficiale. Verniciatura a polveri poliestere.

Cod. 01,02,03,04, RAL su richiesta.

Steel pole consisting of 2 separate elements. First element: circular tubular cross section consisting of one single section. Second element (upper): circular tubular cross section with bent profile. The top end for the assembly of the upper element has an internal flange system with fastening by means of 6 stainless steel side screws. The upper element is made of tubular shaped steel, with double differentiated opposite bend. End part with conical steel tip. Standard connection spigot for units with $\varnothing 76$ mm connections. An adapter spigot is also available on request for units with $\varnothing 60$ mm connections. Cable inlet slot and terminal box slot with finished edges, also suitable for the application of a flush mounted cover door. Hot galvanized in accordance with ISO 1461, and subsequent brushing to ensure perfect surface finish. Polyester powder coating. Cod. 01,02,03,04, RAL on request.



ACCESSORI ACCESSORIES

PZ

Design series | *Designed by*

Marzia Bandini - Massimo Sacconi

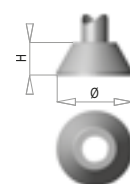

BASE BA/2

	PZ 6 - PZ 7 - PZ 8
H	160
Ø	360

Per il palo PZ 9 non è disponibile la base BA/2
The BA/2 base is not available for the PZ 9 pole



PORTELLA CON MORSETTIERA TERMINAL BLOCK WITH HATCH

	Standard Standard	Filo palo Flush mounted
PZ 6	T-39 G	RESET 16
PZ 7	T-39 G	RESET 16
PZ 8	T-39 G	RESET 17
PZ 9	T-39 G	RESET 17

Disponibili a 1 o 2 fusibili - Available with 1 or 2 fuses

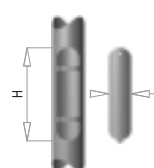

ASOLA MAXI - MAXI TERMINAL BLOCK HOLE

HxL	
	300x85
	400x90

Previa verifica strutturale - Structural verification required
Altre su richiesta - Others upon request

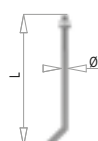

KIT TIRAFONDI - ANCHOR BOLTS

	PZ 6 - PZ 7	PZ 8 - PZ 9
L	500	700
Ø	M 18	M 27

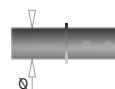

ADATTATORE APPARECCHIO PER ATTACCO LUMINAIRE ADAPTER FOR BRACKET

Ø	60
---	----

		PZ 6	PZ 7	PZ 8	PZ 9	
DIMENSIONI DIMENSIONS	D1	1° Tratto (Ø x spessore) 1 st Section (Ø x spessore)	127x3 mm	127x3 mm	127x3 mm	139x3 mm
	L1	Lunghezza 1° Tratto 1 st Section length	3700 mm	4700 mm	5200 mm	6200 mm
	D2	Ø Braccio Ø Bracket	76x3 mm	76x3 mm	76x3 mm	76x3 mm
	S	Sporgenza Braccio Bracket projection	700 mm	700 mm	750 mm	750 mm
	D3	Codolo (Ø x spessore) Spigot (Ø x spessore)	76x3 mm	76x3 mm	76x3 mm	76x3 mm
	LP	Lunghezza Punta End part length	850 mm	850 mm	850 mm	850 mm
MATERIALI MATERIALS	D1	1° Tratto - 1 st Section	S235 JR	S235 JR	S235 JR	S235 JR
	D2	2° Tratto - 2 nd Section	S235 JR	S235 JR	S235 JR	S235 JR
LAVORAZIONI FINISHING	A1	Asola morsettiera Terminal block hole	186x45 mm	186x45 mm	186x45 mm	186x45 mm
	A2	Asola ingresso cavi Cable slot	186x45 mm	186x45 mm	186x45 mm	186x45 mm
	T	Messa a terra Grounding	Inserito filettato M10, zincato - M10 threaded, galvanized insert			
ALTEZZA HEIGHT	H	Altezza punto luce Luminaire height	6000 mm	7000 mm	8000 mm	9000 mm
	H1	Altezza portella Hatch height	800 mm	800 mm	1000 mm	1000 mm
	H2	Asola passaggio cavi Cable slot height	200 mm	200 mm	200 mm	200 mm
	H3	Altezza fuori terra Above ground height	6870 mm	7870 mm	8870 mm	9870 mm
INTERRAMENTO IN-GROUNDING	P		800 mm	800 mm	800 mm	800 mm
PESO WEIGHT			60 kg	75 kg	90 kg	100 kg

La scelta del palo è soggetta a verifica strutturale effettuata in base alla zona di installazione. AEC procede al dimensionamento e alla verifica della resistenza del sostegno secondo la normativa EN-40.

The pole must be chosen after a structural pole test depending on the area of installation. AEC verifies the dimensioning and the resistance of the column according to the EN-40 standard.

Valori espressi in millimetri | Measures in millimeters

10

9

8

7

6

5

4

3

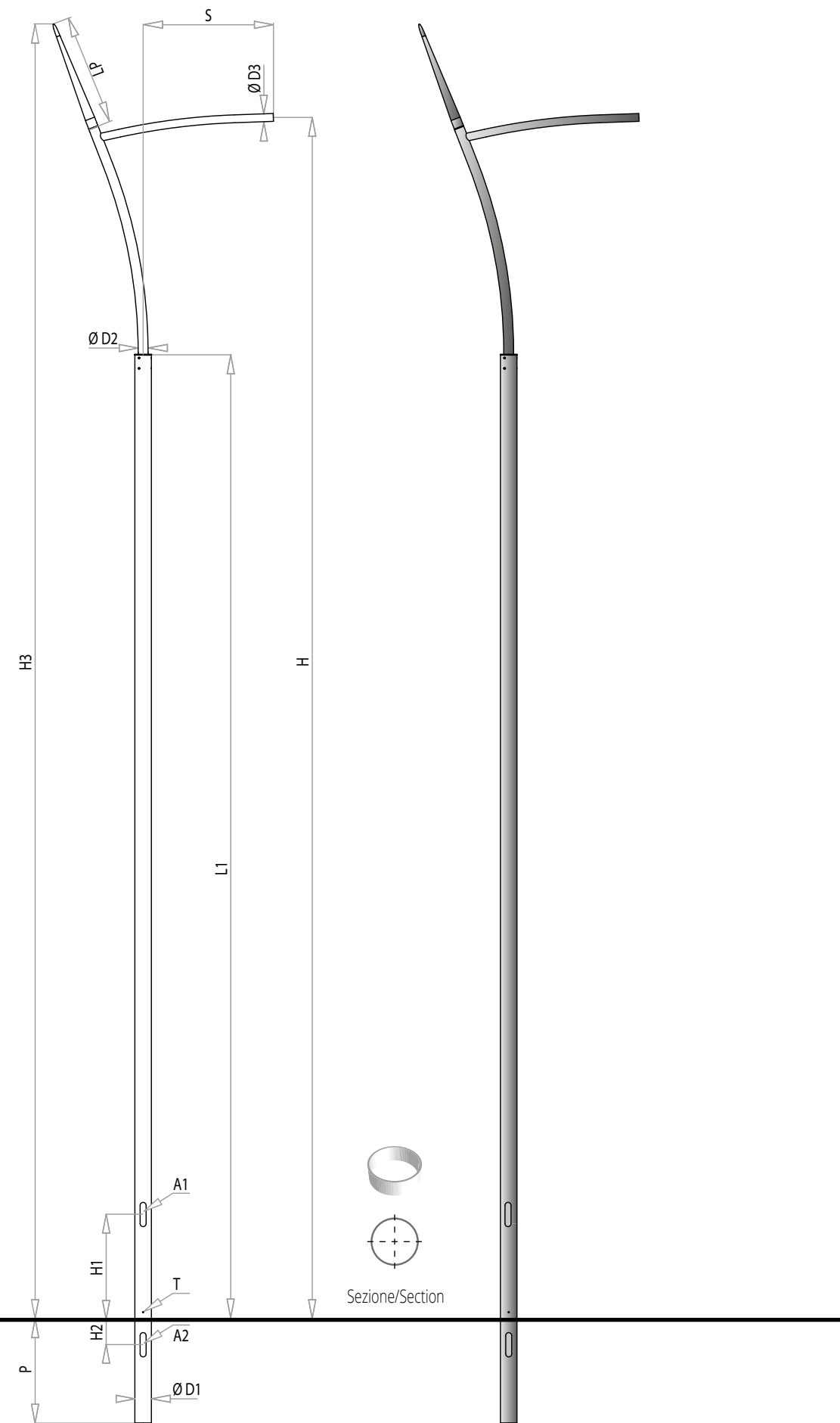

H altezze punto luce
available luminaire heights

Valori espressi in metri | Measures in metres

PE

Design series | Designed by

Marzia Bandini - Massimo Sacconi

Palo in acciaio a sezione circolare realizzato in un unico tratto dotato di mensola singola. La lavorazione di testa per il montaggio del braccio è realizzata con sistema a flangia interna con fissaggio tramite 6 viti laterali in acciaio inox. Il braccio è realizzato in tubolare di acciaio in 2 parti sagomate e successivamente saldate. Codolo di attacco standard idoneo per apparecchi predisposti di attacco Ø 60 mm con puntale in acciaio conificato. Asola ingresso cavi e asola per morsettiera con finitura dei bordi del taglio idonea anche per l'applicazione di portella incassata a filo palo. Zincatura a caldo secondo la norma ISO 1461 e successiva spazzolatura per garantire una perfetta finitura superficiale. Verniciatura a polveri poliestere. Cod. 01,02,03,04, RAL su richiesta.

Steel pole consisting of 2 separate elements. First element: circular tubular cross section consisting of one single section. Second element (upper): circular tubular cross section with bent profile. The top end for the assembly of the upper element has an internal flange system with fastening using 6 stainless steel side screws. The upper element is made of tubular shaped steel, with double differentiated opposite bend. End part with conical steel tip. Standard connection spigot for units with Ø 60 mm connection. Cable inlet slot and terminal box slot with finished edges, also suitable for the application of a flush mounted cover door. Hot galvanized in accordance with ISO 1461, and subsequent brushing to ensure perfect surface finish. Polyester powder coating. Code 01,02,03,04, RAL on request.



ACCESSORI ACCESSORIES

PE

Design series | *Designed by*

Marzia Bandini - Massimo Sacconi

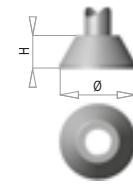

BASE BA/2

	PE 6 - PE 7 - PE 8
H	160
Ø	360

Per il palo PE 9 non è disponibile la base BA/2
The BA/2 base is not available for the PE 9 pole



PORTELLA CON MORSETTIERA TERMINAL BLOCK WITH HATCH

	Standard Standard	Filo palo Flush mounted
PE 6	T-39 G	RESET 16
PE 7	T-39 G	RESET 16
PE 8	T-39 G	RESET 17
PE 9	T-39 G	RESET 17

Disponibili a 1 o 2 fusibili - Available with 1 or 2 fuses

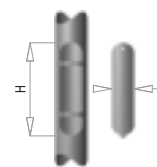

ASOLA MAXI - MAXI TERMINAL BLOCK HOLE

HxL	
	300x85
	400x90

Previa verifica strutturale - Structural verification required
Altre su richiesta - Others upon request

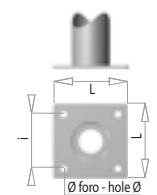

PIASTRA - PLATE

	i	LxL	Ø Foro Hole Ø	Spessore Thickness
PS 6	180	250x250	22	15
PS 7	180	250x250	22	15
PS 8	260	350x350	30	20
PS 9	260	350x350	30	20

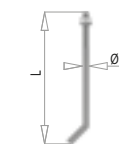

KIT TIRAFONDI - ANCHOR BOLTS

	PE 6 - PE 7	PE 8 - PE 9
L	500	700
Ø	M 18	M 27

Valori espressi in millimetri | Measures in millimeters



		PE 6	PE 7	PE 8	PE 9	
DIMENSIONI DIMENSIONS	D1	1° Tratto (Ø x spessore) 1 st Section (Ø x spessore)	127x3 mm	127x3 mm	127x3 mm	139x3 mm
	L1	Lunghezza 1° Tratto 1 st Section length	4700 mm	5200 mm	6200 mm	7200 mm
	D2	Ø Braccio Ø Bracket	76x3 mm	76x3 mm	76x3 mm	76x3 mm
	S	Sporgenza Braccio Bracket projection	800 mm	1000 mm	1000 mm	1000 mm
	D3	Codolo (Ø x spessore) Spigot (Ø x spessore)	60 mm	60 mm	60 mm	60 mm
	LP	Lunghezza Punta End part length	850 mm	850 mm	850 mm	850 mm
MATERIALI MATERIALS	D1	1° Tratto - 1 st Section	S235 JR	S235 JR	S235 JR	S235 JR
	D2	2° Tratto - 2 nd Section	S235 JR	S235 JR	S235 JR	S235 JR
LAVORAZIONI FINISHING	A1	Asola morsettiera Terminal block hole	186x45 mm	186x45 mm	186x45 mm	186x45 mm
	A2	Asola ingresso cavi Cable slot	186x45 mm	186x45 mm	186x45 mm	186x45 mm
	T	Messa a terra Grounding	Inserito filettato M10, zincato - M10 threaded, galvanized insert			
ALTEZZA HEIGHT	H	Altezza punto luce Luminaire height	6000 mm	7000 mm	8000 mm	9000 mm
	H1	Altezza portella Hatch height	800 mm	800 mm	1000 mm	1000 mm
	H2	Asola passaggio cavi Cable slot height	200 mm	200 mm	200 mm	200 mm
	H3	Altezza fuori terra Above ground height	6780 mm	7740 mm	8740 mm	9740 mm
INTERRAMENTO IN-GROUNDING	P		800 mm	800 mm	800 mm	800 mm
PESO WEIGHT			60 kg	75 kg	85 kg	100 kg

La scelta del palo è soggetta a verifica strutturale effettuata in base alla zona di installazione. AEC procede al dimensionamento e alla verifica della resistenza del sostegno secondo la normativa EN-40.

The pole must be chosen after a structural pole test depending on the area of installation. AEC verifies the dimensioning and the resistance of the column according to the EN-40 standard.

10

9

8

7

6

5

4

3

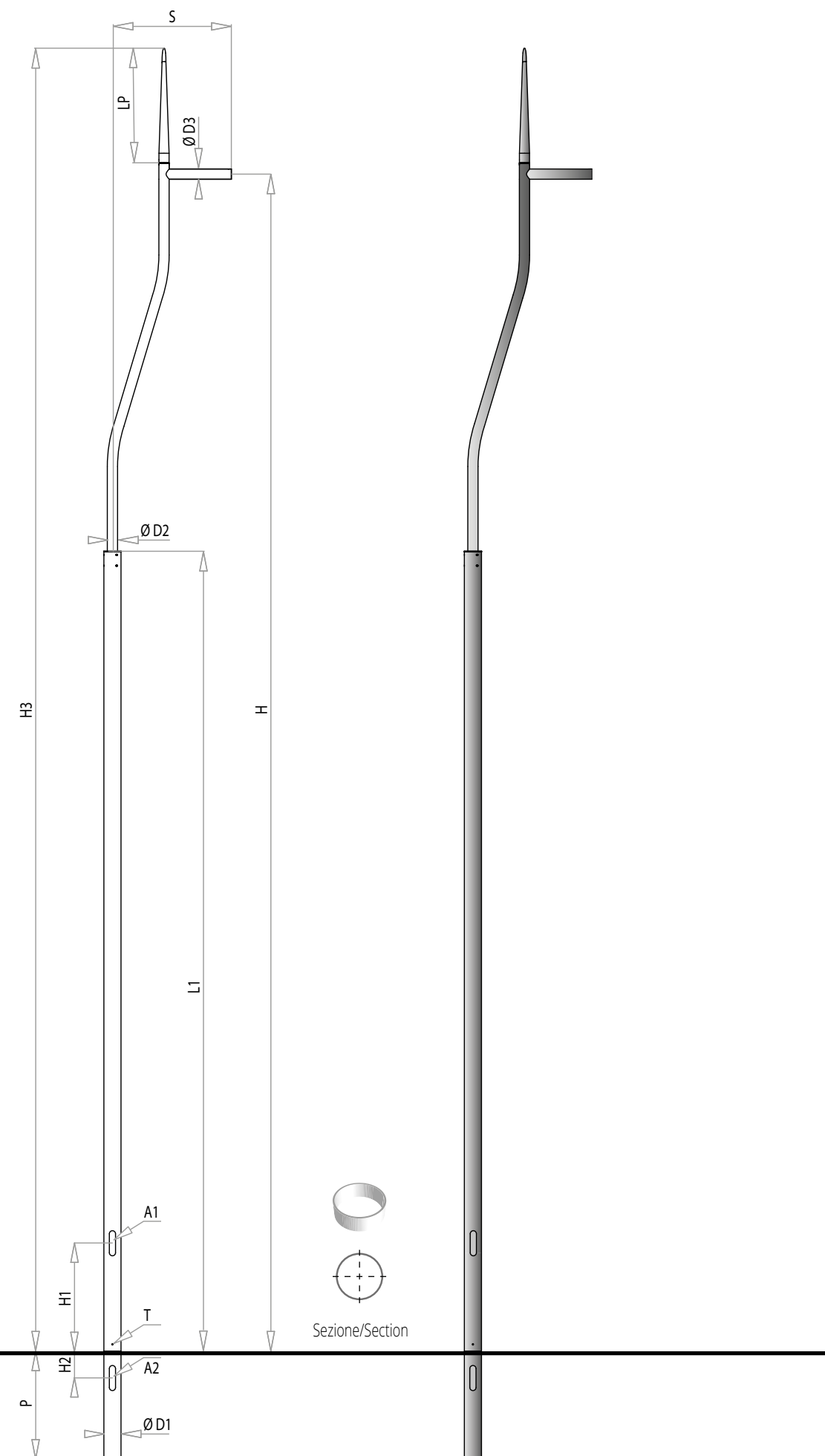

PH

Design series | Designed by

Marzia Bandini - Massimo Sacconi

Palo in acciaio composto da 2 elementi contraddistinti: 1. Prima parte: sezione tubolare circolare realizzata in un unico tratto. 2. Seconda parte (superiore): sezione tubolare circolare a profilo curvato. La lavorazione di testa per il montaggio della parte superiore è realizzata con sistema a flangia interna con fissaggio tramite 6 viti laterali in acciaio inox. La parte superiore è realizzata in tubolare di acciaio sagomato a doppia curvatura differenziata contrapposta parte finale con puntale in acciaio conificato. Codolo di attacco standard idoneo per apparecchi predisposti di attacco Ø 76 mm. Codolo adattatore disponibile per apparecchi con attacco Ø 60 mm (opzionale). Asola ingresso cavi e asola per morsettiera con finitura dei bordi del taglio idonea anche per l'applicazione di portella incassata a filo palo. Zincatura a caldo secondo la norma ISO 1461 e successiva spazzolatura per garantire una perfetta finitura superficiale. Verniciatura a polveri poliesteri. Cod. 01,02,03,04, RAL su richiesta.

Steel pole consisting of 2 separate elements. First element: circular tubular cross section consisting of one single section. Second element (upper): circular tubular cross section with bent profile. The top end for the assembly of the upper element has an internal flange system with fastening using 6 stainless steel side screws. The upper element is made of tubular shaped steel, with double differentiated opposite bend. Standard connection spigot for units with Ø 76 mm connection. An adapter spigot is also available on request for units with Ø 60 mm connections. Cable inlet slot and terminal box slot with finished edges, also suitable for the application of a flush mounted cover door. Hot galvanized in accordance with ISO 1461, and subsequent brushing to ensure perfect surface finish. Polyester powder coating. Code 01,02,03,04, RAL on request.



ACCESSORI ACCESSORIES

PH

Design series | Designed by

Marzia Bandini - Massimo Sacconi

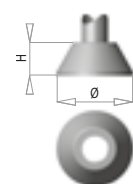
**BASE BA/2**

	PH 6 - PH 7 - PH 8
H	160
Ø	360

Per il palo PH 9 non è disponibile la base BA/2
The BA/2 base is not available for the PH 9 pole

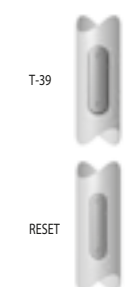
**PORTELLA CON MORSETTIERA
TERMINAL BLOCK WITH HATCH**

	Standard Standard	Filo palo Flush mounted
PH 6	T-39 G	RESET 16
PH 7	T-39 G	RESET 16
PH 8	T-39 G	RESET 17
PH 9	T-39 G	RESET 17

Disponibili a 1 o 2 fusibili - Available with 1 or 2 fuses

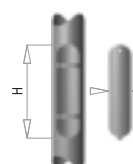
**ASOLA MAXI - MAXI TERMINAL BLOCK HOLE**

HxL	
	300x85
	400x90

Previa verifica strutturale - Structural verification required
Altre su richiesta - Others upon request

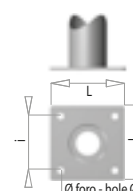
**PIASTRA - PLATE**

	i	LxL	Ø Foro Hole Ø	Spessore Thickness
PH 6	180	250x250	22	15
PH 7	180	250x250	22	15
PH 8	260	350x350	30	20
PH 9	260	350x350	30	20

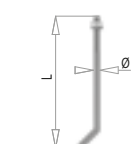
**KIT TIRAFONDI - ANCHOR BOLTS**

	PH 6 - PH 7	PH 8 - PH 9
L	500	700
Ø	M 18	M 27

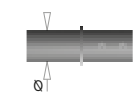
**ADATTATORE APPARECCHIO PER ATTACCO
LUMINAIRE ADAPTER FOR BRACKET**

Ø	60
----------	----

Valori espressi in millimetri | Measures in millimeters

		PH 6	PH 7	PH 8	PH 9	
DIMENSIONI DIMENSIONS	D1	1° Tratto (Ø x spessore) 1 st Section (Ø x spessore)	127x3 mm	127x3 mm	127x3 mm	139x3 mm
	L1	Lunghezza 1° Tratto 1 st Section length	3700 mm	4700 mm	5200 mm	6200 mm
	D2	Ø Braccio Ø Bracket	76x3 mm	76x3 mm	76x3 mm	76x3 mm
	S	Sporgenza Braccio Bracket projection	880 mm	880 mm	880 mm	880 mm
	D3	Codolo (Ø x spessore) Spigot (Ø x spessore)	76 mm	76 mm	76 mm	76 mm
	LP	Lunghezza Puntale End part length	850 mm	850 mm	850 mm	850 mm
MATERIALI MATERIALS	D1	1° Tratto - 1 st Section	S235 JR	S235 JR	S235 JR	S235 JR
	D2	2° Tratto - 2 nd Section	S235 JR	S235 JR	S235 JR	S235 JR
LAVORAZIONI FINISHING	A1	Asola morsettiera Terminal block hole	186x45 mm	186x45 mm	186x45 mm	186x45 mm
	A2	Asola ingresso cavi Cable slot	186x45 mm	186x45 mm	186x45 mm	186x45 mm
	T	Messa a terra Grounding	Inserito filettato M10, zincato - M10 threaded, galvanized insert			
ALTEZZA HEIGHT	H	Altezza punto luce Luminaire height	6000 mm	7000 mm	8000 mm	9000 mm
	H1	Altezza portella Hatch height	800 mm	800 mm	1000 mm	1000 mm
	H2	Asola passaggio cavi Cable slot height	200 mm	200 mm	200 mm	200 mm
	H3	Altezza fuori terra Above ground height	6870 mm	7870 mm	8870 mm	9870 mm
INTERRAMENTO IN-GROUNDING	P		800 mm	800 mm	800 mm	800 mm
PESO WEIGHT			60 kg	75 kg	90 kg	100 kg

La scelta del palo è soggetta a verifica strutturale effettuata in base alla zona di installazione. AEC procede al dimensionamento e alla verifica della resistenza del sostegno secondo la normativa EN-40.

The pole must be chosen after a structural pole test depending on the area of installation. AEC verifies the dimensioning and the resistance of the column according to the EN-40 standard.

10

9

8

7

6

5

4

3

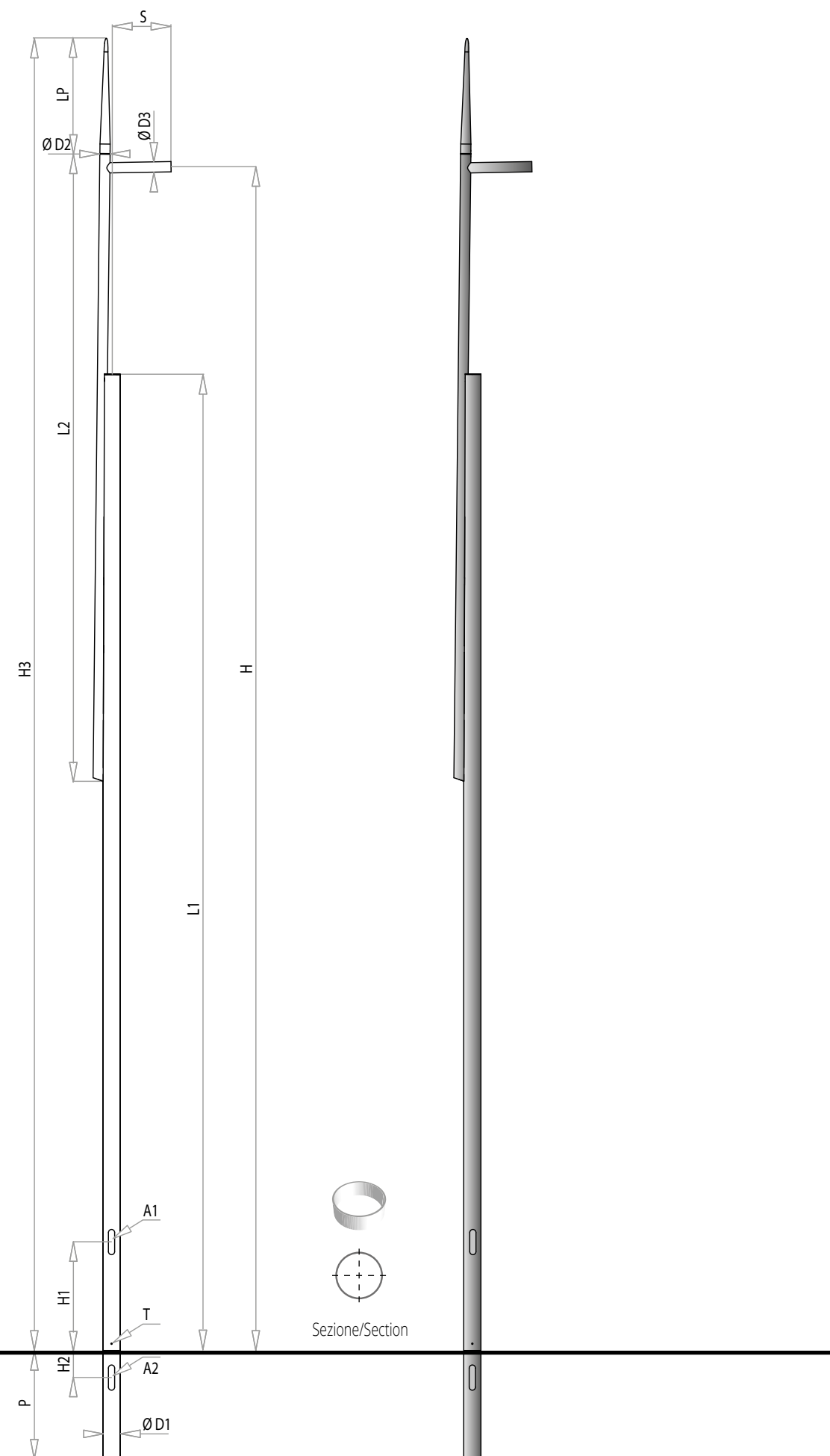

H altezze punto luce
available luminaire heights

PB

Design series | Designed by

Marzia Bandini - Massimo Sacconi

Palo in acciaio a sezione circolare composto da due elementi tubolari di diverso diametro incastrati nella parte laterale e successivamente saldati tra di essi. Il tratto superiore è inclinato rispetto al tratto inferiore e può disporre di un faretto spot (opzionale) per illuminazione decorativa lato marciapiede a luce LED bianca o colorata tramite sistema RGB. La parte superiore è predisposta di codolo per il montaggio di corpi illuminanti con attacco $\varnothing 76$ mm. Codolo laterale per la composizione di doppio corpo illuminante sfalsato (opzionale). Parte finale con puntale in acciaio conico. Asola ingresso cavi e asola per morsettiera con finitura dei bordi del taglio idonea anche per l'applicazione di portella incassata a filo palo. Zincatura a caldo secondo la norma ISO 1461 e successiva spazzolatura per garantire una perfetta finitura superficiale. Verniciatura a polveri poliesteri.

Cod. 01, RAL su richiesta.

Circular cross section steel pole consisting of two tubular elements of different diameters, mortised at the side and subsequently welded to each other. The top element is tilted in relation to the bottom element, and can house a spot beam (optional) for decorative lighting on the pavement side, either white LED, or coloured light using the RGB system. The upper element has a spigot for the installation of lighting bodies with $\varnothing 76$ mm connections. A further side spigot is also available on request for compositions with double offset lighting body. End part with conical steel tip. Cable inlet slot and terminal box slot with finished edges, also suitable for the application of a flush mounted cover door. Hot galvanized in accordance with ISO 1461, and subsequent brushing to ensure perfect surface finish. Polyester powder coating. Code 01, RAL on request.



ACCESSORI ACCESSORIES

PB

Design series | Designed by

Marzia Bandini - Massimo Sacconi

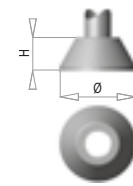

BASE BA/2

	PB 6 - PB 7 - PB 8
H	160
Ø	360

Per il palo PB 9 non è disponibile la base BA/2
The BA/2 base is not available for the PB 9 pole



PORTELLA CON MORSETTIERA TERMINAL BLOCK WITH HATCH

	Standard Standard	Filo palo Flush mounted
PB 6	T-39 G	RESET 16
PB 7	T-39 G	RESET 16
PB 8	T-39 G	RESET 17
PB 9	T-39 G	RESET 17

Disponibili a 1 o 2 fusibili - Available with 1 or 2 fuses

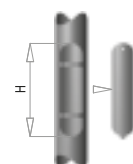

ASOLA MAXI - MAXI TERMINAL BLOCK HOLE

HxL	
	300x85
	400x90

Previa verifica strutturale - Structural verification required
Altre su richiesta - Others upon request

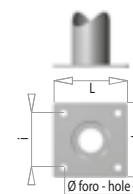

PIASTRA - PLATE

	i	LxL	Ø Foro Hole Ø	Spessore Thickness
PB 6	180	250x250	22	15
PB 7	180	250x250	22	15
PB 8	260	350x350	30	20
PB 9	260	350x350	30	20

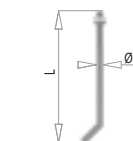

KIT TIRAFONDI - ANCHOR BOLTS

	PB 6 - PB 7	PB 8 - PB 9
L	500	700
Ø	M 18	M 27

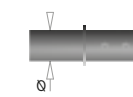

ADATTATORE APPARECCHIO PER ATTACCO LUMINAIRE ADAPTER FOR BRACKET

Ø	
	60



FARETTO SPOT - SPOTLIGHT

APERTURA - BEAM	40°
APERTURA - BEAM	
COLORE - COLOUR	

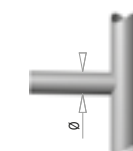

BRACCETTO LATERALE PER PUNTO LUCE SFALZATO LATERAL BRACKET FOR STAGGERED LUMINAIRE

SPORGENZA - PROJECTION	250
Ø	76

Valori espressi in millimetri | Measures in millimeters



		PB 6	PB 7	PB 8	PB 9	
DIMENSIONI DIMENSIONS	D1	1° Tratto (Ø x spessore) 1 st Section (Ø x thickness)	127x3 mm	127x3 mm	127x3 mm	139x3 mm
	L1	Lunghezza 1° Tratto 1 st Section length	4200 mm	5200 mm	6200 mm	7200 mm
	D2	2° Tratto (Ø x spessore) 2 nd Section (Ø x thickness)	76x3 mm	76x3 mm	76x3 mm	76x3 mm
	L2	Lunghezza 2° Tratto 2 nd Section length	3000 mm	4 000 mm	4000 mm	5000 mm
	S	Sporgenza codolo Spigot projection	430 mm	430 mm	430 mm	430 mm
	D3	Codolo (Ø x spessore) Spigot (Ø x thickness)	76x3 mm	76x3 mm	76x3 mm	76x3 mm
	LP	Lunghezza Puntale End part length	850 mm	850 mm	850 mm	850 mm
MATERIALI MATERIALS	D1	1° Tratto - 1 st Section	S235 JR	S235 JR	S235 JR	S235 JR
	D2	2° Tratto - 2 nd Section	S235 JR	S235 JR	S235 JR	S235 JR
LAVORAZIONI FINISHING	A1	Asola morsettiera Terminal block hole	186x45 mm	186x45 mm	186x45 mm	186x45 mm
	A2	Asola ingresso cavi Cable slot	186x45 mm	186x45 mm	186x45 mm	186x45 mm
	T	Messa a terra Grounding	Inserito filettato M10, zincato - M10 threaded, galvanized insert			
ALTEZZA HEIGHT	H	Altezza punto luce Luminaire height	6000 mm	7000 mm	8000 mm	9000 mm
	H1	Altezza portella Hatch height	800 mm	800 mm	1000 mm	1000 mm
	H2	Asola passaggio cavi Cable slot height	200 mm	200 mm	200 mm	200 mm
	H3	Altezza fuori terra Above ground height	7050 mm	8050 mm	9050 mm	10050 mm
INTERRAMENTO IN-GROUNDING	P		800 mm	800 mm	800 mm	800 mm
PESO WEIGHT			55 kg	68 kg	82 kg	105 kg

La scelta del palo è soggetta a verifica strutturale effettuata in base alla zona di installazione. AEC procede al dimensionamento e alla verifica della resistenza del sostegno secondo la normativa EN-40.

The pole must be chosen after a structural pole test depending on the area of installation. AEC verifies the dimensioning and the resistance of the column according to the EN-40 standard.

15

14

13

12

11

10

9

8



Ø foro

hole Ø

Piastra/Plate

Sezione/Section

H3

H

H1

A1

BABEL

Palo conico in acciaio a sezione pseudo-triangolare, composto da due tratti realizzati mediante presso-piegatura e saldatura e assemblati meccanicamente in fase di installazione a creare un unico tratto. Doppia asola per morsettiera. Zincatura a caldo secondo la norma ISO 1461 e successiva spazzolatura per garantire una perfetta finitura superficiale. Verniciatura a polveri poliestere. Bianco satinato marmorizzato semilucido COD. 2D.

Conical pole in steel featured by a pseudo-triangular section and composed of two parts made through press-bending and welding processes. The two parts are mechanically assembled during the installation in order to create a single section. Double terminal box slot. Hot galvanized in accordance with ISO 1461, and subsequent brushing to ensure perfect surface finish. Polyester powder coating. Satin marbled semi-gloss white, COD. 2D.



ACCESSORI ACCESSORIES

BABEL



PORTELLA CON MORSETTIERA TERMINAL BLOCK WITH HATCH

	Standard Standard
BABEL 15	T-39 Q

Disponibili a 1 o 2 fusibili - Available with 1 or 2 fuses

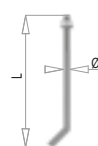

KIT TIRAFONDI - ANCHOR BOLTS

	BABEL 15
L	600
Ø	M 22

Valori espressi in millimetri | Measures in millimeters

6 MODULI | MODULES

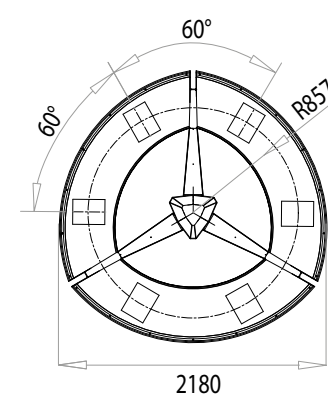

12 MODULI | MODULES

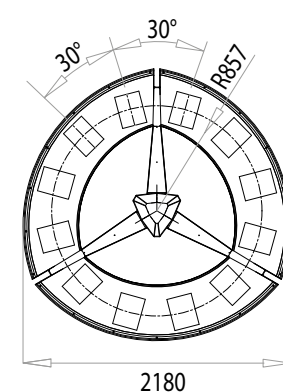

16 MODULI | MODULES

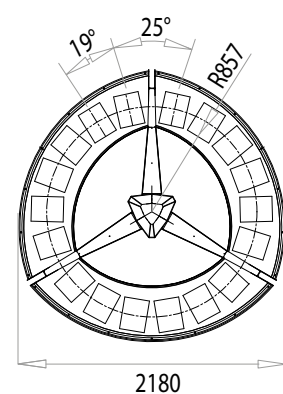

		BABEL 15	
DIMENSIONI DIMENSIONS	D1	1° Tratto (Ø x spessore) 1 st Section (Ø x thickness)	390x4 mm
	D2	2° Tratto (Ø x spessore) 2 nd Section (Ø x thickness)	196x4 mm
	D3	Codolo (Ø x spessore) Spigot (Ø x thickness)	2180 mm
MATERIALI MATERIALS			5235 JR
LAVORAZIONI FINISHING	A1	Asola morsettiere Terminal block hole	186x45 mm
	B	Messa a terra Grounding	Dimensione (LxL) Dimension (LxL)
Ø foro Hole Ø			26 mm
ALTEZZA HEIGHT	H	Altezza punto luce Luminaire height	15000 mm
	H1	Altezza portella Hatch height	1000 mm
	H3	Altezza fuori terra Above ground height	5745 mm
PESO WEIGHT			442 kg

La scelta del palo è soggetta a verifica strutturale effettuata in base alla zona di installazione. AEC procede al dimensionamento e alla verifica della resistenza del sostegno secondo la normativa EN-40.

The pole must be chosen after a structural pole test depending on the area of installation. AEC verifies the dimensioning and the resistance of the column according to the EN-40 standard.



10

9

8

7

6

5

4

3



H altezze punto luce
available luminaire heights

Valori espressi in metri | Measures in metres

Palo conico in acciaio saldato e scordonato, realizzato in un unico tratto piegato longitudinalmente con finale in materiale plastico. Il palo è dotato di codolo standard dal diametro di 60 mm. Fissaggio interrato. Asola per morsettiera con finitura dei bordi del taglio idonea anche per l'applicazione di portella incassata a filo palo. Zincatura a caldo secondo la norma ISO 1461 e successiva spazzolatura per garantire una perfetta finitura superficiale. Verniciatura a polveri poliestere. Cod. 01,02,03,04, RAL su richiesta.

Conical steel pole, welded and de-beaded, consisting of one single longitudinally bent section. Conical drawn aluminium tip with plastic end. The pole has a double standard shank with 60 mm diameter. Underground fixing. Terminal box slot with finished edges, also suitable for the application of a flush mounted cover. Hot galvanized in accordance with ISO 1461, and subsequent brushing to ensure perfect surface finish. Polyester powder coating. Code 01, RAL on request.



ACCESSORI ACCESSORIES



PORTELLA CON MORSETTIERA TERMINAL BLOCK WITH HATCH

	Standard Standard	Filo palo Flush mounted
PI 6	T-39	RESET 15
PI 7	T-39 G	RESET 16
PI 8	T-39 G	RESET 17
PI 9	T-39 G	RESET 17
PI 10	T-39 G	RESET 18

Disponibili a 1 o 2 fusibili - Available with 1 or 2 fuses

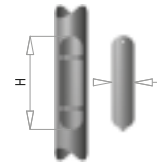

ASOLA MAXI - MAXI TERMINAL BLOCK HOLE

HxL	
	300x65
	400x90*

Previa verifica strutturale - Structural verification required
Altre su richiesta - Others upon request
* Escluso PI 6, PI 7 - Except PI 6, PI 7

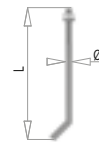

KIT TIRAFONDI - ANCHOR BOLTS

	PI 6 - PI 7 - PI 8	PI 9 - PI 10
L	500	700
Ø	M 18	M 20

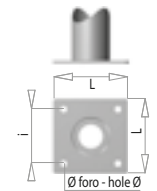

PIASTRA - PLATE

	i	LxL	Ø Foro Hole Ø	Spessore Thickness
PI 6	180	250x250	22	12
PI 7	200	300x300	22	12
PI 8	200	300x300	22	15
PI 9	250	350x350	24	15
PI 10	250	350x350	24	15

		PI 6	PI 7	PI 8	PI 9	PI 10		
DIMENSIONI DIMENSIONS	D1	Dimensione alla base (Ø x spessore) Dimension at the base (Ø x thickness)		136 mm	146 mm	156 mm	166 mm	176 mm
	D2	Dimensione in testa (Ø) Dimension at the top (Ø)		60 mm	60 mm	60 mm	60 mm	60 mm
	D3	Codolo (Ø) Spigot (Ø)		60 mm	60 mm	60 mm	60 mm	60 mm
MATERIALI MATERIALS	D1	Tratto unico Single section		S235 JR	S235 JR	S235 JR	S235 JR	S235 JR
LAVORAZIONI FINISHING	A1	Asola morsettiera Terminal block hole		186x45 mm	186x45 mm	186x45 mm	186x45 mm	186x45 mm
	T	Messa a terra Grounding		Inserito filettato M10, zincato - M10 threaded, galvanized insert				
ALTEZZA HEIGHT	H	Altezza punto luce Luminaire height		6000 mm	7000 mm	8000 mm	9000 mm	10000 mm
	H1	Altezza portella Hatch height		1000 mm	1000 mm	1000 mm	1000 mm	1000 mm
	H2	Asola passaggio cavi Cable slot height		200 mm	200 mm	200 mm	200 mm	200 mm
	H3	Altezza fuori terra Above ground height		6600 mm	7600 mm	8600 mm	9600 mm	10600 mm
INTERRAMENTO IN-GROUNDING	P			800 mm	800 mm	800 mm	800 mm	800 mm
PESO WEIGHT				55 kg	65 kg	76 kg	116 kg	132 kg

La scelta del palo è soggetta a verifica strutturale effettuata in base alla zona di installazione. AEC procede al dimensionamento e alla verifica della resistenza del sostegno secondo la normativa EN-40.

The pole must be chosen after a structural pole test depending on the area of installation. AEC verifies the dimensioning and the resistance of the column according to the EN-40 standard.

Valori espressi in millimetri | Measures in millimeters

10

9

8

7

6

5

4

3

Valori espressi in metri | Measures in metres



H altezze punto luce
available luminaire heights

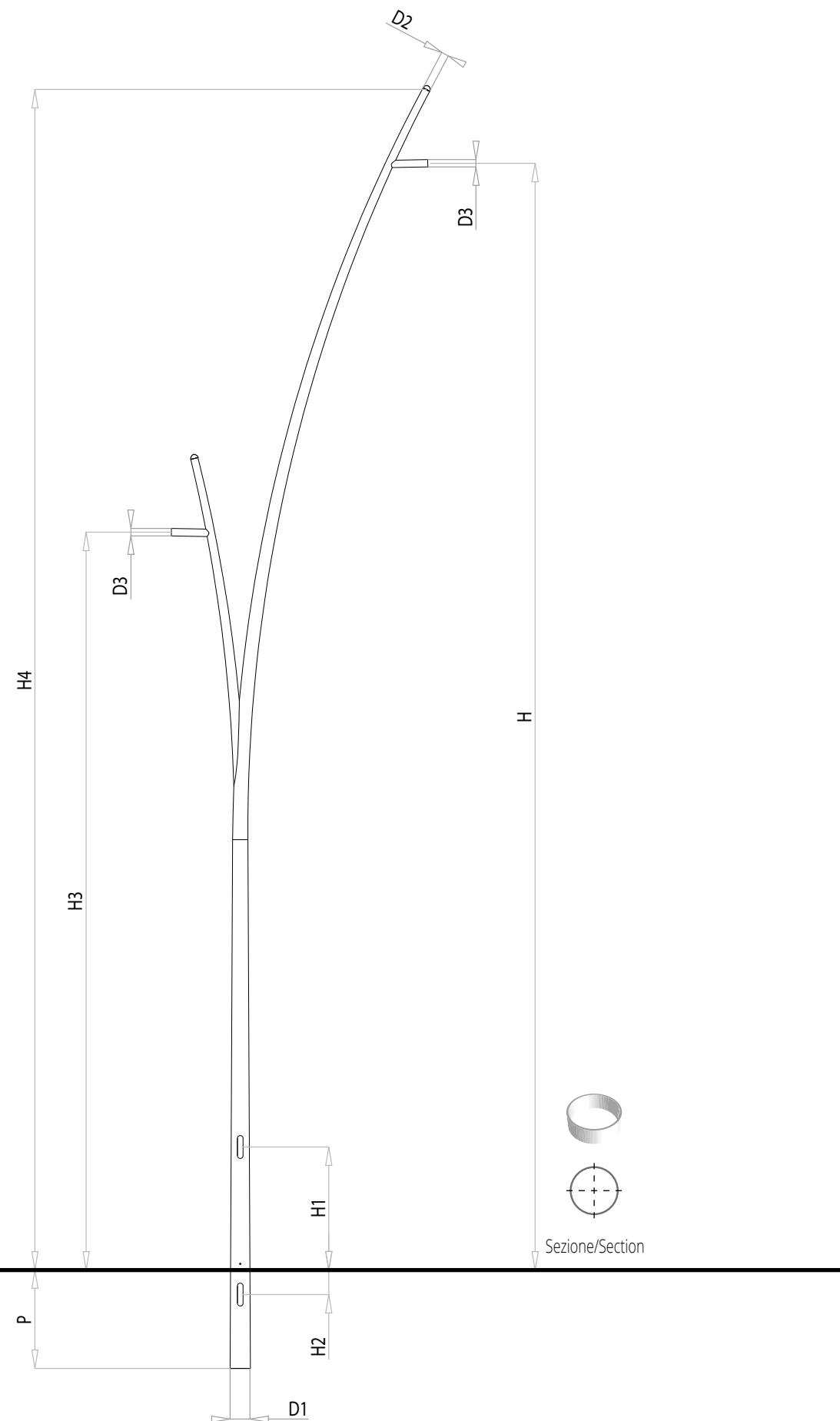

PI S2

Palo conico in acciaio saldato e scordonato, realizzato in doppio tratto piegato longitudinalmente con finale in materiale plastico. Il palo è dotato di codolo standard dal diametro di 60 mm. Fissaggio interrato. Asola per morsettiera con finitura dei bordi del taglio idonea anche per l'applicazione di portella incassata a filo palo. Zincatura a caldo secondo la norma ISO 1461 e successiva spazzolatura per garantire una perfetta finitura superficiale. Verniciatura a polveri poliestere. Cod. 01,02,03,04, RAL su richiesta.

Conical steel pole, welded and de-beaded, consisting of double longitudinally bent section. Conical drawn aluminium tip with plastic end. The pole has a double standard shank with 60 mm diameter. Underground fixing. Terminal box slot with finished edges, also suitable for the application of a flush mounted cover. Hot galvanized in accordance with ISO 1461, and subsequent brushing to ensure perfect surface finish. Polyester powder coating. Code 01, RAL on request.

ACCESSORI ACCESSORIES

PI S2



PORTELLA CON MORSETTIERA TERMINAL BLOCK WITH HATCH

	Standard Standard	Filo palo Flush mounted
PI 6 S2	T-39	RESET 15
PI 7 S2	T-39 G	RESET 16
PI 8 S2	T-39 G	RESET 17
PI 9 S2	T-39 G	RESET 17
PI 10 S2	T-39 G	RESET 18

Disponibili a 1 o 2 fusibili - Available with 1 or 2 fuses

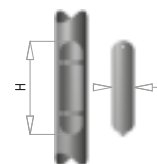

ASOLA MAXI - MAXI TERMINAL BLOCK HOLE

HxL	
	300x65
	400x90*

Previa verifica strutturale - Structural verification required
Altre su richiesta - Others upon request
* Escluso PI 6 S2, PI 7 S2 - Except PI 6 S2, PI 7 S2

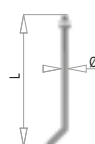

KIT TIRAFONDI - ANCHOR BOLTS

	PI 6 S2 - PI 7 S2 - PI 8 S2	PI 9 S2 - PI 10 S2
L	500	700
Ø	M 18	M 24

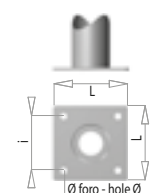

PIASTRA - PLATE

	i	LxL	Ø Foro Hole Ø	Spessore Thickness
PI 6 S2	180	250x250	22	12
PI 7 S2	200	300x300	22	15
PI 8 S2	200	300x300	22	15
PI 9 S2	250	350x350	28	15
PI 10 S2	250	350x350	28	20

		PI 6 S2	PI 7 S2	PI 8 S2	PI 9 S2	PI 10 S2	
DIMENSIONI DIMENSIONS	D1	Dimensione alla base (Ø x spessore) Dimension at the base (Ø x thickness)	136 mm	146 mm	156 mm	166 mm	176 mm
	D2	Dimensione in testa (Ø) Dimension at the top (Ø)	60 mm	60 mm	60 mm	60 mm	60 mm
	D3	Codolo (Ø) Spigot (Ø)	60 mm	60 mm	60 mm	60 mm	60 mm
MATERIALI MATERIALS	D1	Tratto unico Single section	S235 JR	S235 JR	S235 JR	S235 JR	S355 JR
LAVORAZIONI FINISHING	A1	Asola morsettiera Terminal block hole	186x45 mm	186x45 mm	186x45 mm	186x45 mm	186x45 mm
	T	Messa a terra Grounding	Inserito filettato M10, zincato - M10 threaded, galvanized insert				
ALTEZZA HEIGHT	H	Altezza punto luce Luminaire height	6000 mm	7000 mm	8000 mm	9000 mm	10000 mm
	H1	Altezza portella Hatch height	1000 mm	1000 mm	1000 mm	1000 mm	1000 mm
	H2	Asola passaggio cavi Cable slot height	200 mm	200 mm	200 mm	200 mm	200 mm
	H3	Altezza punto luce sfalzato Staggered luminaire height	4000 mm	5000 mm	5500 mm	6000 mm	7000 mm
	H4	Altezza fuori terra Above ground height	6600 mm	7600 mm	8600 mm	9600 mm	10600 mm
INTERRAMENTO IN-GROUNDING	P		800 mm	800 mm	800 mm	800 mm	800 mm
PESO WEIGHT			68 kg	102 kg	118 kg	135 kg	156 kg

La scelta del palo è soggetta a verifica strutturale effettuata in base alla zona di installazione. AEC procede al dimensionamento e alla verifica della resistenza del sostegno secondo la normativa EN-40.

The pole must be chosen after a structural pole test depending on the area of installation. AEC verifies the dimensioning and the resistance of the column according to the EN-40 standard.

Valori espressi in millimetri | Measures in millimeters

10

9

8

7

6

5

4

3

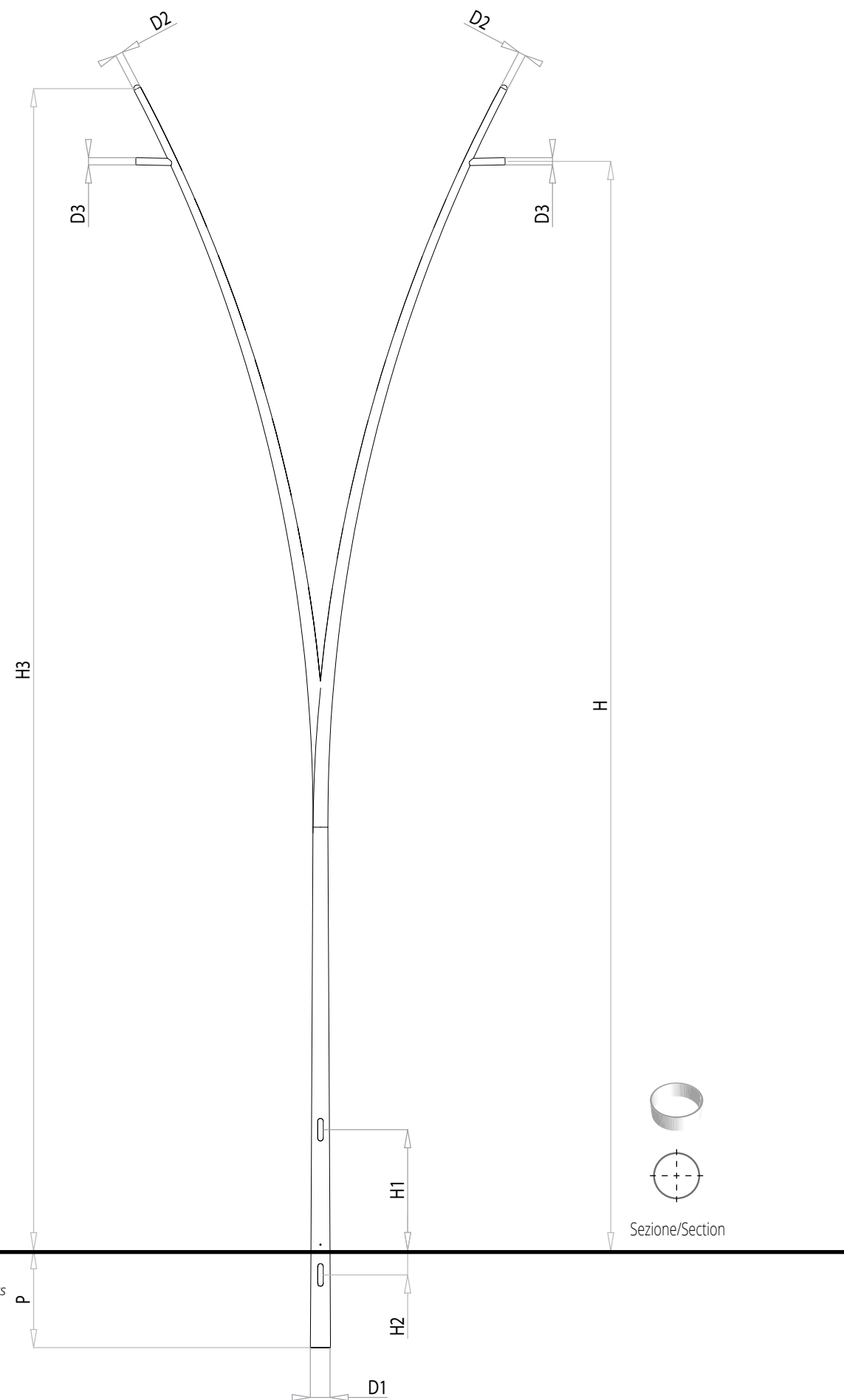

H altezze punto luce
available luminaire heights

P

D1

H2

H1

H

H3

D3

D3

D2

D2

Sezione/Section

PI D2

Palo conico in acciaio saldato e scordonato, realizzato in doppio tratto piegato longitudinalmente con finali in materiale plastico. Il palo è dotato di doppio codolo standard dal diametro di 60 mm. Asola per morsettiera con finitura dei bordi del taglio idonea anche per l'applicazione di portella incassata a filo palo. Zincatura a caldo secondo la norma ISO 1461 e successiva spazzolatura per garantire una perfetta finitura superficiale. Verniciatura a polveri poliestere. Cod. 01,02,03,04, RAL su richiesta.

Conical steel pole, welded and de-beaded, consisting of double longitudinally bent section with plastic ends. The pole has a double standard shank with 60 mm diameter. Conical drawn aluminium tip with plastic end. Terminal box slot with finished edges, also suitable for the application of a flush mounted cover. Hot galvanized in accordance with ISO 1461, and subsequent brushing to ensure perfect surface finish. Polyester powder coating. Code 01, RAL on request.

ACCESSORI ACCESSORIES

PI D2



PORTELLA CON MORSETTIERA TERMINAL BLOCK WITH HATCH

	Standard Standard	Filo palo Flush mounted
PI 6 D2	T-39	RESET 15
PI 7 D2	T-39 G	RESET 16
PI 8 D2	T-39 G	RESET 17
PI 9 D2	T-39 G	RESET 17
PI 10 D2	T-39 G	RESET 18

Disponibili a 1 o 2 fusibili - Available with 1 or 2 fuses

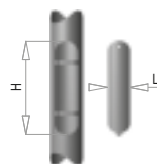

ASOLA MAXI - MAXI TERMINAL BLOCK HOLE

HxL	
	300x65
	400x90*

Previa verifica strutturale - Structural verification required
Altre su richiesta - Others upon request

* Escluso PI 6 D2, PI 7 D2 - Except PI 6 D2, PI 7 D2.

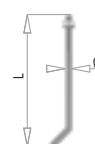

KIT TIRAFONDI - ANCHOR BOLTS

	PI 6 D2	PI 7 D2	PI 8 D2 - PI 9 D2	PI 10 D2
L	500	700	700	700
Ø	M 18	M 20	M 24	M 27

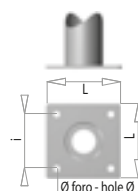

PIASTRA - PLATE

	i	LxL	Ø Foro Hole Ø	Spessore Thickness
PI 6 D2	180	250x250	22	15
PI 7 D2	200	300x300	24	15
PI 8 D2	200	300x300	28	15
PI 9 D2	250	350x350	28	20
PI 10 D2	250	350x350	32	20

		PI 6 D2	PI 7 D2	PI 8 D2	PI 9 D2	PI 10 D2	
DIMENSIONI DIMENSIONS	D1	Dimensione alla base (Ø x spessore) Dimension at the base (Ø x thickness)	136 mm	146 mm	156 mm	166 mm	176 mm
	D2	Dimensione in testa (Ø) Dimension at the top (Ø)	60 mm	60 mm	60 mm	60 mm	60 mm
	D3	Codolo (Ø) Spigot (Ø)	60 mm	60 mm	60 mm	60 mm	60 mm
MATERIALI MATERIALS	D1	Tratto unico Single section	S235 JR	S235 JR	S235 JR	S355 JR	S355 JR
LAVORAZIONI FINISHING	A1	Asola morsettiera Terminal block hole	186x45 mm	186x45 mm	186x45 mm	186x45 mm	186x45 mm
	T	Messa a terra Grounding	Inserito filettato M10, zincato - M10 threaded, galvanized insert				
ALTEZZA HEIGHT	H	Altezza punto luce Luminaire height	6000 mm	7000 mm	8000 mm	9000 mm	10000 mm
	H1	Altezza portella Hatch height	1000 mm	1000 mm	1000 mm	1000 mm	1000 mm
	H2	Asola passaggio cavi Cable slot height	200 mm	200 mm	200 mm	200 mm	200 mm
	H3	Altezza fuori terra Above ground height	6600 mm	7600 mm	8600 mm	9600 mm	10600 mm
INTERRAMENTO IN-GROUNDING	P		800 mm	800 mm	800 mm	800 mm	800 mm
PESO WEIGHT			80 kg	114 kg	135 kg	155 kg	180 kg

La scelta del palo è soggetta a verifica strutturale effettuata in base alla zona di installazione. AEC procede al dimensionamento e alla verifica della resistenza del sostegno secondo la normativa EN-40.

The pole must be chosen after a structural pole test depending on the area of installation. AEC verifies the dimensioning and the resistance of the column according to the EN-40 standard.

Valori espressi in millimetri | Measures in millimeters

10

9

8

7

6

5

4

3

Valori espressi in metri | Measures in metres

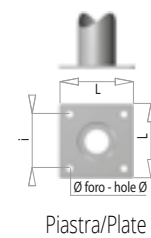

Piastra/Plate

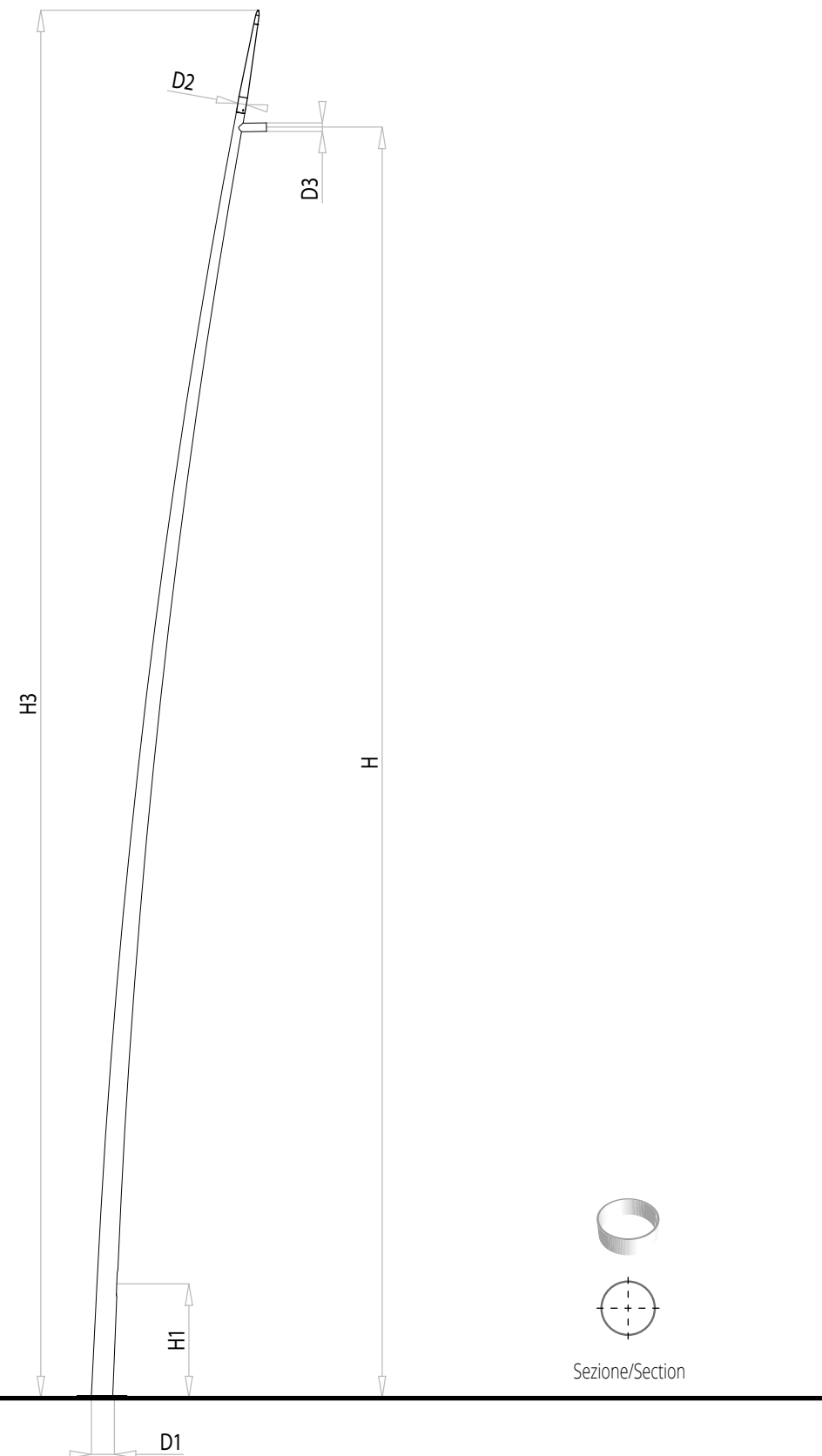

Sezione/Section

H altezze punto luce
available luminaire heights

PV

Palo conico in acciaio saldato e scordonato, realizzato in un unico tratto piegato longitudinalmente. Puntale conico in alluminio trafilato con finale in materiale plastico. Il palo è dotato di codolo standard diametro 60 mm. Fissaggio con piastra di base. Asola per morsettiera con finitura dei bordi del taglio idonea anche per l'applicazione di portella incassata a filo palo. Zincatura a caldo secondo la norma ISO 1461 e successiva spazzolatura per garantire una perfetta finitura superficiale. Verniciatura a polveri poliesteri. Cod. 01,02,03,04, RAL su richiesta.

Conical steel pole, welded and de-beaded, consisting of one single longitudinally bent section. Conical drawn aluminium tip with plastic end. The pole has a standard spigot for the installation with 60 mm of diameter. Fastening base plate. Terminal box slot with finished edges, also suitable for the application of a flush mounted cover. Hot galvanized in accordance with ISO 1461, and subsequent brushing to ensure perfect surface finish. Polyester powder coating. Code 01,02,03,04, RAL on request.

ACCESSORI ACCESSORIES

PV



PORTELLA CON MORSETTIERA TERMINAL BLOCK WITH HATCH

	Standard Standard	Filo palo Flush mounted
PV 6	T-39	RESET 12
PV 7	T-39 G	RESET 15
PV 8	T-39 G	RESET 16
PV 9	T-39 G	RESET 17
PV 10	T-39 G	RESET 18

Disponibili a 1 o 2 fusibili - Available with 1 or 2 fuses

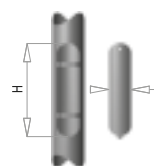

ASOLA MAXI - MAXI TERMINAL BLOCK HOLE

HxL	
	300x65
	400x90*

Previa verifica strutturale - Structural verification required
Altre su richiesta - Others upon request
* Escluso PV 6, PV 7 - Except PV 6, PV 7

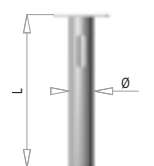

CONTROPIASTRA INTERRAMENTO IN-GROUNDING PLATE

L	
	850
Ø	139

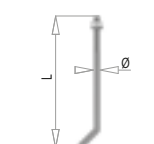

KIT TIRAFONDI - ANCHOR BOLTS

	PV 6 - PV 7 - PV 8	PV 9 - PV 10
L	500	700
Ø	M 18	M 20

		PV 6	PV 7	PV 8	PV 9	PV 10		
DIMENSIONI DIMENSIONS	D1	Dimensione alla base (Ø x spessore) Dimension at the base (Ø x thickness)		121 mm	131 mm	141 mm	151 mm	161 mm
	D2	Dimensione in testa (Ø) Dimension at the top (Ø)		60 mm	60 mm	60 mm	60 mm	60 mm
	D3	Codolo (Ø) Spigot (Ø)		60 mm	60 mm	60 mm	60 mm	60 mm
MATERIALI MATERIALS	D1	Tratto unico Single section		S235 JR	S235 JR	S235 JR	S355 JR	S355 JR
	A1	Asola morsettiera Terminal block hole		186x45 mm	186x45 mm	186x45 mm	186x45 mm	186x45 mm
LAVORAZIONI FINISHING	B	Piastra di base Base plate	Dimensione (LxL) Dimension (LxL)	250x250 mm	300x300 mm	300x300 mm	350x350 mm	350x350 mm
			Interasse (i) Spacing (i)	148 mm	198 mm	198 mm	230 mm	230 mm
			Ø foro Hole Ø	22 mm	22 mm	22 mm	24 mm	24 mm
			Spessore Thickness	12 mm	12 mm	15 mm	15 mm	15 mm
T	Messa a terra Grounding	Inserito filettato M10, zincato - M10 threaded, galvanized insert						
ALTEZZA HEIGHT	H	Altezza punto luce Luminaire height		5900 mm	6900 mm	7900 mm	8900 mm	9900 mm
	H1	Altezza portella Hatch height		800 mm	800 mm	800 mm	800 mm	800 mm
	H3	Altezza fuori terra Above ground height		6700 mm	7700 mm	8700 mm	9700 mm	10700 mm
PESO WEIGHT				50 kg	60 kg	71 kg	85 kg	122 kg

La scelta del palo è soggetta a verifica strutturale effettuata in base alla zona di installazione. AEC procede al dimensionamento e alla verifica della resistenza del sostegno secondo la normativa EN-40.

The pole must be chosen after a structural pole test depending on the area of installation. AEC verifies the dimensioning and the resistance of the column according to the EN-40 standard.

Valori espressi in millimetri | Measures in millimeters

10

9

8

7

6

5

4

3

Valori espressi in metri | Measures in metres

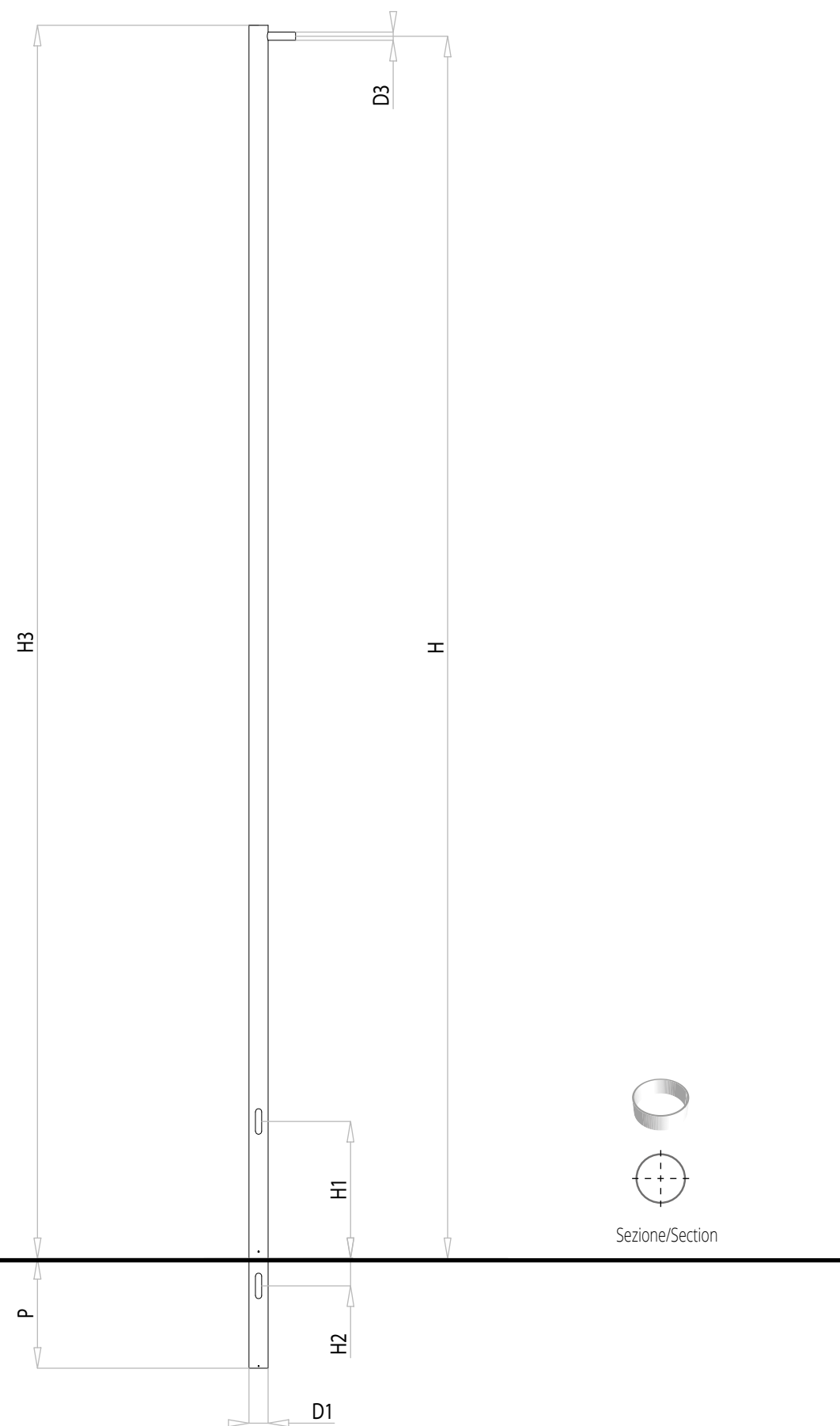

H altezze punto luce
available luminaire heights

Palo in acciaio a sezione circolare realizzato in un unico tratto. Il palo è dotato di codolo laterale del diametro di 60 mm. Asola ingresso cavi e asola per morsettiera con finitura dei bordi del taglio idonea anche per l'applicazione di portella incassata a filo palo. Zincatura a caldo secondo la norma ISO 1461 e successiva spazzolatura per garantire una perfetta finitura superficiale. Verniciatura a polveri poliestere. Cod. 01,02,03,04, RAL su richiesta.

Circular section steel pole made in one section. The pole has a 60 mm side shank. Cable entry slot and terminal block slot with finishing of the edges of the cut also suitable for the application of recessed door flush with the pole. Hot dip galvanizing according to ISO 1461 and subsequent brushing to guarantee a perfect surface finish. Polyester powder painting. Cod. 01,02,03,04, RAL on request.

ACCESSORI ACCESSORIES

P0



PORTELLA CON MORSETTIERA TERMINAL BLOCK WITH HATCH

	Standard Standard	Filo palo Flush mounted
P0 5	T-39	RESET 11
P0 6	T-39 G	RESET 16
P0 7	T-39 G	RESET 16
P0 8	T-39 G	RESET 16
P0 9	T-39 G	RESET 17

Disponibili a 1 o 2 fusibili - Available with 1 or 2 fuses

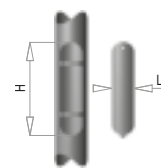

ASOLA MAXI - MAXI TERMINAL BLOCK HOLE

HxL	P0 5	P0 6 - P0 7 - P0 8 - P0 9
	300 x 65	400 x 90

Previa verifica strutturale - Structural verification required
Altre su richiesta - Others upon request
* Escluso P0 5, P0 6 - P0 7. Except P0 6 - P0 7.

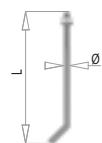

KIT TIRAFONDI - ANCHOR BOLTS

	P0 7 - P0 8	P0 9
L	500	700
Ø	M 18	M 20

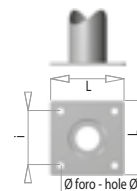

PIASTRA - PLATE

	i	LxL	Ø Foro Hole Ø	Spessore Thickness
P0 5	180	250x250	22	10
P0 6	180	250x250	22	10
P0 7	180	250x250	22	12
P0 8	180	250x250	22	12
P0 9	200	300x300	24	15

		P0 5	P0 6	P0 7	P0 8	P0 9		
DIMENSIONI DIMENSIONS	D1	Dimensione alla base (Ø x spessore) Dimension at the base (Ø x thickness)		102 mm	127 mm	127 mm	127 mm	139 mm
	D3	Codolo (Ø) Spigot (Ø)		60 mm	60 mm	60 mm	60 mm	60 mm
MATERIALI MATERIALS	D1	Tratto unico Single section		S235 JR	S235 JR	S235 JR	S355 JR	S355 JR
LAVORAZIONI FINISHING	A1	Asola morsettiera Terminal block hole		186x45 mm	186x45 mm	186x45 mm	186x45 mm	186x45 mm
	T	Messa a terra Grounding		Insero filettato M10, zincato - M10 threaded, galvanized insert				
ALTEZZA HEIGHT	H	Altezza punto luce Luminaire height		4900 mm	5900 mm	6900 mm	7900 mm	8900 mm
	H1	Altezza portella Hatch height		1000 mm	1000 mm	1000 mm	1000 mm	1000 mm
	H2	Asola passaggio cavi Cable slot height		200 mm	200 mm	200 mm	200 mm	200 mm
	H3	Altezza fuori terra Above ground height		5000 mm	6000 mm	7000 mm	8000 mm	9000 mm
INTERRAMENTO IN-GROUNDING	P			500 mm	800 mm	800 mm	800 mm	800 mm
PESO WEIGHT				42 kg	64 kg	73 kg	82 kg	100 kg

La scelta del palo è soggetta a verifica strutturale effettuata in base alla zona di installazione. AEC procede al dimensionamento e alla verifica della resistenza del sostegno secondo la normativa EN-40.

The pole must be chosen after a structural pole test depending on the area of installation. AEC verifies the dimensioning and the resistance of the column according to the EN-40 standard.

Valori espressi in millimetri | Measures in millimeters

10

9

8

7

6

5

4

3

Valori espressi in metri | Measures in metres

ACCESSORI ACCESSORIES

PX

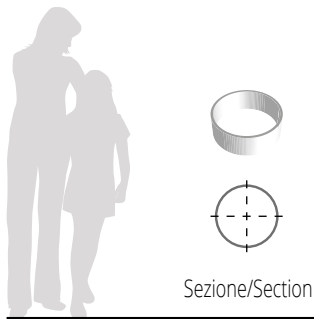

Sezione/Section

H altezze punto luce
available luminaire heights

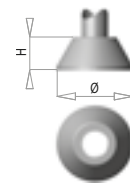
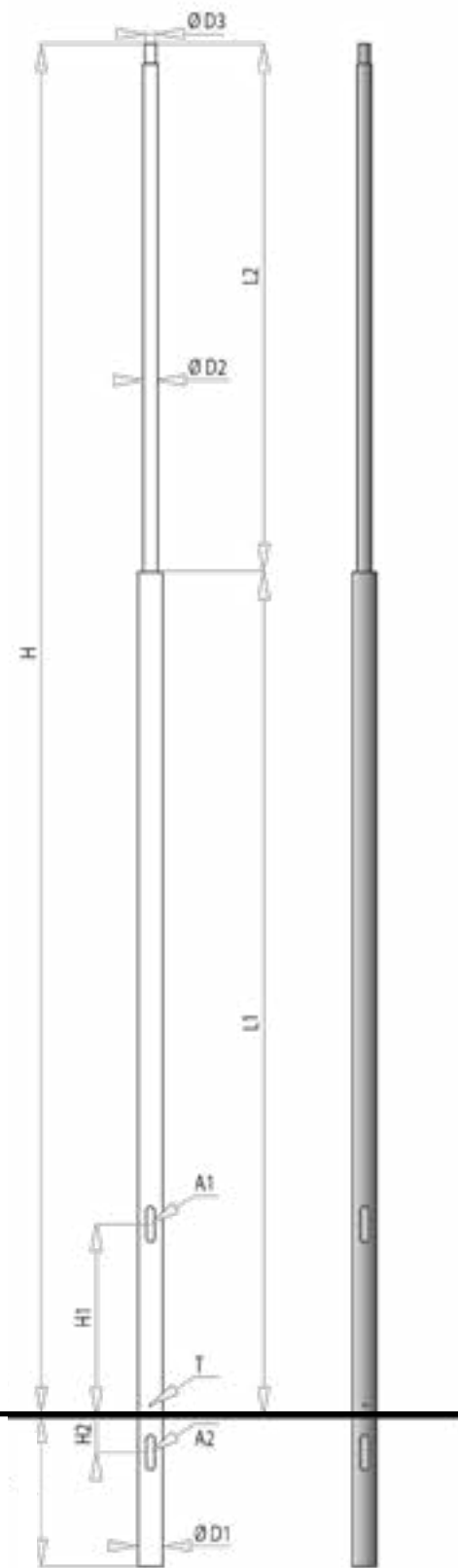

BASE BA/1

	PX 4 - PX 5	
H	160	
Ø	260	



PORTELLA CON MORSETTIERA
TERMINAL BLOCK WITH HATCH

	Standard Standard	Filo palo Flush mounted
PX 4	T-39	RESET 11
PX 5	T-39	RESET 11
PX 6	T-39-G	RESET 16
PX 7	T-39-G	RESET 16
PX 8	T-39-G	RESET 16

Disponibili a 1 o 2 fusibili - Available with 1 or 2 fuses

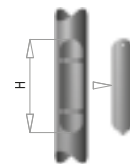

ASOLA MAXI - MAXI TERMINAL BLOCK HOLE

HxL	300x85
-----	--------

Previa verifica strutturale - Structural verification required
Altre su richiesta - Others upon request

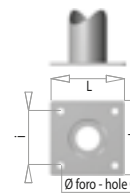

PIASTRA - PLATE

	i	LxL	Ø Foro Hole Ø	Spessore Thickness
PX 4	180	250x250	22	10
PX 5	180	250x250	22	10
PX 6	180	250x250	22	15
PX 7	180	250x250	22	15
PX 8	260	350x350	26	20

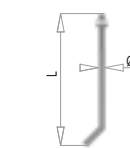

KIT TIRAFONDI - ANCHOR BOLTS

	PX 4 - PX 5 - PX 6 - PX 7	PX 8
L	500	500
Ø	M 18	M 22

Valori espressi in millimetri | Measures in millimeters

Palo in acciaio a sezione circolare rastremato con rondella di giunzione a forma piatta composto da due tratti e codolo finale, realizzato con elementi tubolari saldati in sequenza. Asola ingresso cavi e asola per morsetti con finitura dei bordi del taglio idonea anche per l'applicazione di portella incassata a filo palo.
Zincatura a caldo secondo la norma ISO 1461 e successiva spazzolatura per garantire una perfetta finitura superficiale. Verniciatura a polveri poliesteri.
Cod. 01,02,03,04, RAL su richiesta.

Circular cross section steel pole with plane junction washer, consisting in two sections, made of two joint elements welded in sequence. Cable inlet slot and terminal box slot with finished edges, also suitable for the application of a flush mounted cover door.
Hot galvanized in accordance with ISO 1461, and subsequent brushing to ensure perfect surface finish. Polyester powder coating.
Code 01,02,03,04, RAL on request.

		PX 4	PX 5	PX 6	PX 7	PX 8	
DIMENSIONI DIMENSIONS	D1	1° Tratto (Ø x spessore) 1° Section (Ø x thickness)	102x3mm	102x3 mm	114x3 mm	127x3 mm	127x3 mm
	D2	2° Tratto (Ø x spessore) 2° Section (Ø x thickness)	76x3mm	76x3 mm	76x3mm	76x3mm	76x3mm
	D3	Codolo finale Final spigot	60	60	60	60	60
MATERIALE MATERIAL		S235JR	S235JR	S235JR	S235JR	S235JR	
LAVORAZIONI FINISHING	A1	Asola morsettiere Terminal block hole	186x45 mm	186x45 mm	186x45 mm	186x45 mm	186x45 mm
	A2	Asola ingresso cavi Cable slot	132x38 mm	132x38 mm	186x45 mm	186x45 mm	186x45 mm
	T	Messa a terra Grounding	Inserito filettato M10, zincato - M10 threaded, galvanized insert				
ALTEZZA HEIGHT	H	Altezza punto luce Luminaire height	4000 mm	5000 mm	6000 mm	7000 mm	8000 mm
	H1	Altezza portella Hatch height	800 mm	800 mm	800 mm	1000 mm	1000 mm
	H2	Asola passaggio cavi Cable slot height	200 mm	200 mm	200 mm	200 mm	200 mm
INTERRAMENTO IN-GROUNDING	P		500 mm	500 mm	500 mm	800 mm	800 mm
PESO WEIGHT			31 kg	38 kg	51 kg	64 kg	70 kg

La scelta del palo è soggetta a verifica strutturale effettuata in base alla zona di installazione. AEC procede al dimensionamento e alla verifica della resistenza del sostegno secondo la normativa EN-40.
The pole must be chosen after a structural pole test depending on the area of installation. AEC verifies the dimensioning and the resistance of the column according to the EN-40 standard.



Artistico | *Decorative*



APPLICAZIONI SU PALO APPLICATIONS ON POLES

La linea "decorative" di AEC è sintesi di un'accurata ricerca sulle moderne tecnologie industriali applicate all'arte dei maestri artigiani. Una collezione di candelabri in ghisa e corpi illuminanti dai decori in stile classico, in grado di valorizzare i centri storici delle nostre città conferendo loro uno stile senza tempo. Grazie alla diffusione della tecnologia LED, gli apparecchi della serie artistico si rinnovano, vestendo le nostre città di nuova luce.

The AEC "decorative" range is the synthesis of a detailed research in modern industrial technologies, applied to the art of master craftsmen. A collection of cast iron luminaires and lighting bodies with a classic European décor, capable of enhancing the old town centres of our cities, by giving them a timeless feeling. Thanks to the widespread LED technology, the units of the decorative range renew themselves, dressing our cities with new light.



1



1. Florence (Italy)



APPLICAZIONI SU PALO
APPLICATIONS ON POLES

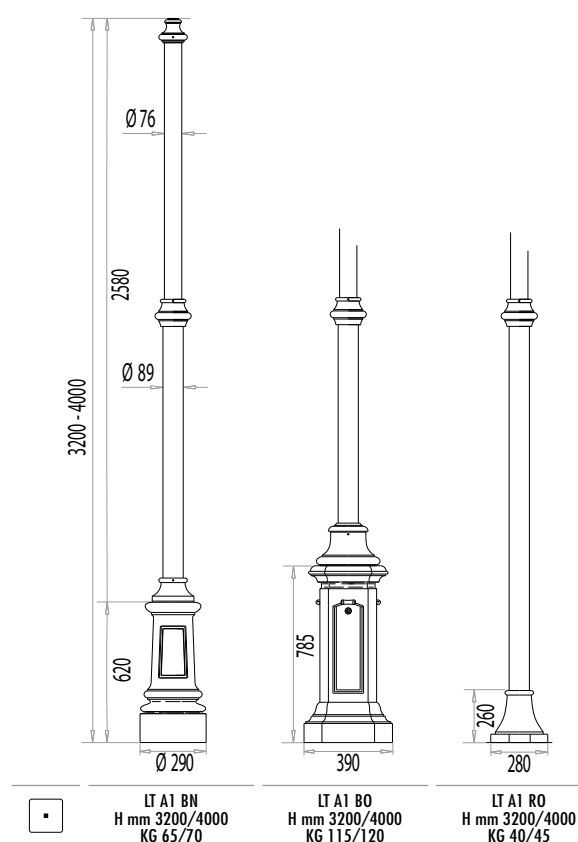
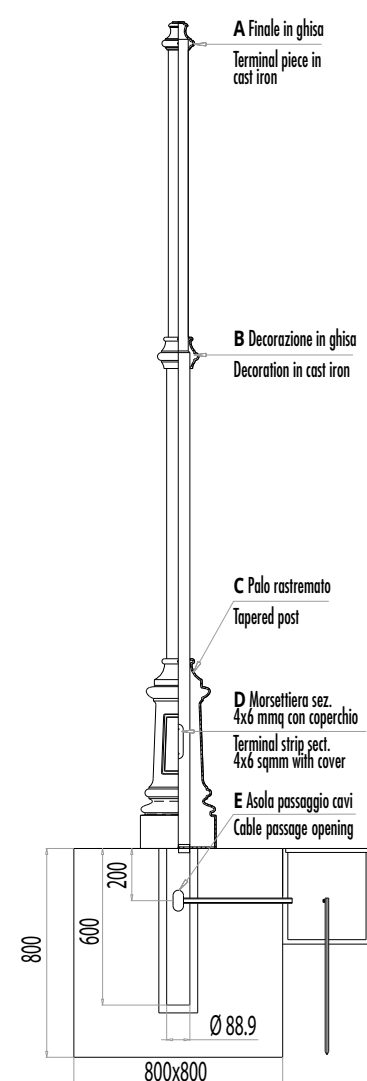

Modelli depositati | Registered design - Scala | Scale 1:30

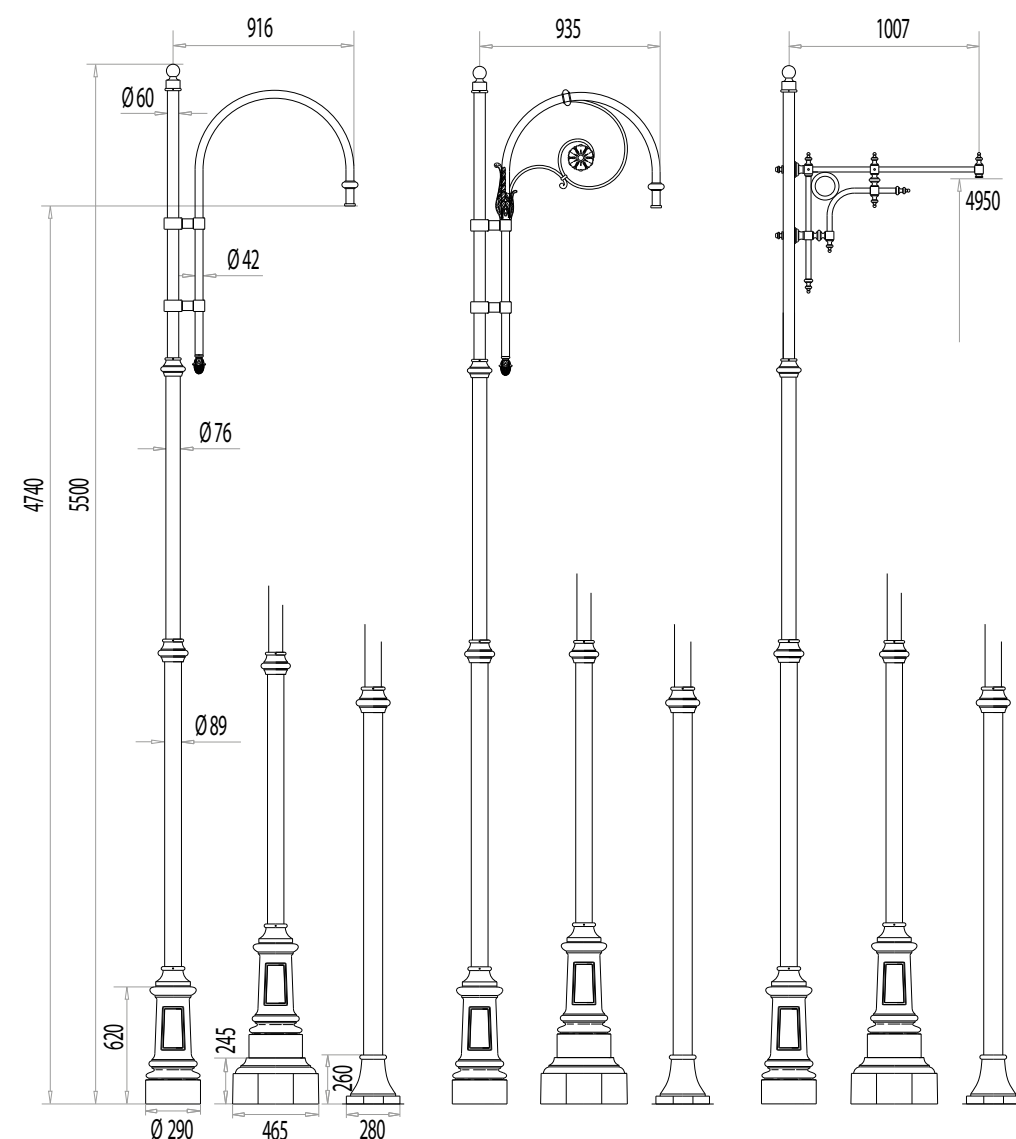

□	LT S1 BN H mm 5500 KG 90	LT S1 SN H mm 5500 KG 115	LT S1 RO H mm 5500 KG 58	LT M1 BN H mm 5500 KG 100	LT M1 SN H mm 5500 KG 125	LT M1 RO H mm 5500 KG 68	LT L1 BN H mm 5500 KG 97	LT L1 SN H mm 5500 KG 122	LT L1 RO H mm 5500 KG 65
□	LT S2 BN H mm 5500 KG 100	LT S2 SN H mm 5500 KG 125	LT S2 RO H mm 5500 KG 68	LT M2 BN H mm 5500 KG 120	LT M2 SN H mm 5500 KG 145	LT M2 RO H mm 5500 KG 88			
□	LT S3 BN H mm 5500 KG 110	LT S3 SN H mm 5500 KG 135	LT S3 RO H mm 5500 KG 78	LT M3 BN H mm 5500 KG 130	LT M3 SN H mm 5500 KG 155	LT M3 RO H mm 5500 KG 98			

Modelli depositati | Registered design - Scala | Scale 1:40

APPLICAZIONI SU PALO APPLICATIONS ON POLES

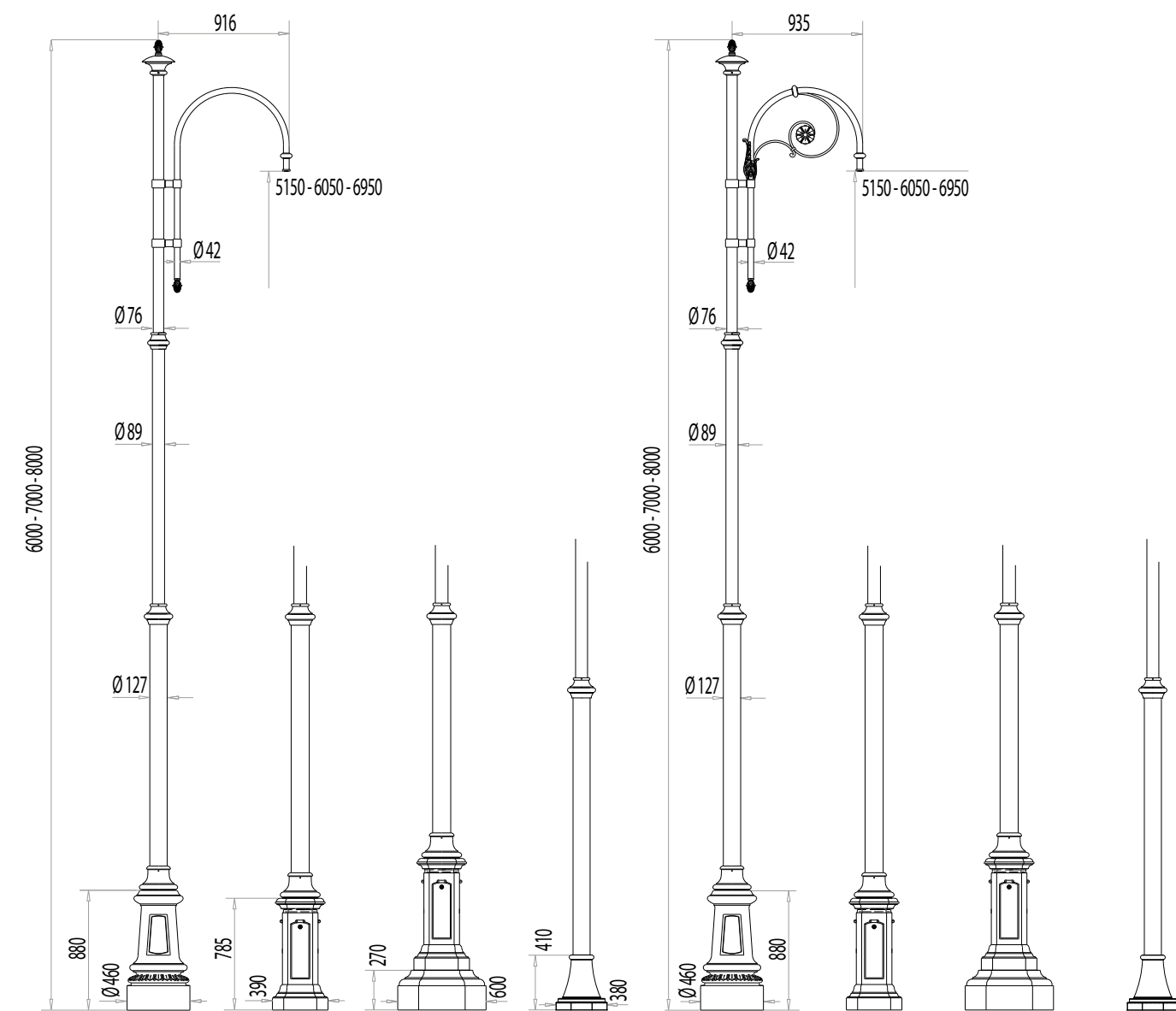

□	LT S1 BC6 H mm 6000 - KG 197	LT S1 B06 H mm 6000 - KG 188	LT S1 BT6 H mm 6000 - KG 242	LT S1 R06 H mm 6000 - KG 128	LT M1 BC6 H mm 6000 - KG 206	LT M1 B06 H mm 6000 - KG 197	LT M1 BT6 H mm 6000 - KG 251	LT M1 R06 H mm 6000 - KG 137
□	LT S1 BC7 H mm 7000 - KG 206	LT S1 B07 H mm 7000 - KG 197	LT S1 BT7 H mm 7000 - KG 251	LT S1 R07 H mm 7000 - KG 135	LT M1 BC7 H mm 7000 - KG 215	LT M1 B07 H mm 7000 - KG 206	LT M1 BT7 H mm 7000 - KG 260	LT M1 R07 H mm 7000 - KG 146
□	LT S1 BC8 H mm 8000 - KG 215	LT S1 B08 H mm 6000 - KG 206	LT S1 BT8 H mm 8000 - KG 260	LT S1 R08 H mm 6000 - KG 146	LT M1 BC8 H mm 8000 - KG 224	LT M1 B08 H mm 8000 - KG 215	LT M1 BT8 H mm 8000 - KG 269	LT M1 R08 H mm 8000 - KG 155
□	LT S2 BC6 H mm 6000 - KG 210	LT S2 B06 H mm 6000 - KG 201	LT S2 BT6 H mm 6000 - KG 255	LT S2 R06 H mm 6000 - KG 150	LT M2 BC6 H mm 6000 - KG 228	LT M2 B06 H mm 6000 - KG 219	LT M2 BT6 H mm 6000 - KG 273	LT M2 R06 H mm 6000 - KG 159
□	LT S2 BC7 H mm 7000 - KG 219	LT S2 B07 H mm 7000 - KG 210	LT S2 BT7 H mm 7000 - KG 264	LT S2 R07 H mm 7000 - KG 159	LT M2 BC7 H mm 7000 - KG 237	LT M2 B07 H mm 7000 - KG 228	LT M2 BT7 H mm 7000 - KG 282	LT M2 R07 H mm 7000 - KG 168
□	LT S2 BC8 H mm 8000 - KG 228	LT S2 B08 H mm 8000 - KG 219	LT S2 BT8 H mm 8000 - KG 273	LT S2 R08 H mm 8000 - KG 168	LT M2 BC8 H mm 8000 - KG 246	LT M2 B08 H mm 8000 - KG 237	LT M2 BT8 H mm 8000 - KG 291	LT M2 R08 H mm 8000 - KG 177
□	LT S3 BC6 H mm 6000 - KG 227	LT S3 B06 H mm 6000 - KG 218	LT S3 BT6 H mm 6000 - KG 272	LT S3 R06 H mm 6000 - KG 158	LT M3 BC6 H mm 6000 - KG 254	LT M3 B06 H mm 6000 - KG 245	LT M3 BT6 H mm 6000 - KG 299	LT M3 R06 H mm 6000 - KG 185
□	LT S3 BC7 H mm 7000 - KG 236	LT S3 B07 H mm 7000 - KG 227	LT S3 BT7 H mm 7000 - KG 281	LT S3 R07 H mm 7000 - KG 167	LT M3 BC7 H mm 7000 - KG 263	LT M3 B07 H mm 7000 - KG 254	LT M3 BT7 H mm 7000 - KG 308	LT M3 R07 H mm 7000 - KG 194
□	LT S3 BC8 H mm 8000 - KG 245	LT S3 B08 H mm 8000 - KG 236	LT S3 BT8 H mm 8000 - KG 290	LT S3 R08 H mm 8000 - KG 176	LT M3 BC8 H mm 8000 - KG 272	LT M3 B08 H mm 8000 - KG 263	LT M3 BT8 H mm 8000 - KG 317	LT M3 R08 H mm 8000 - KG 203

Modelli depositati | Registered design - Scala | Scale 1:40

APPLICAZIONI SU PALO APPLICATIONS ON POLES

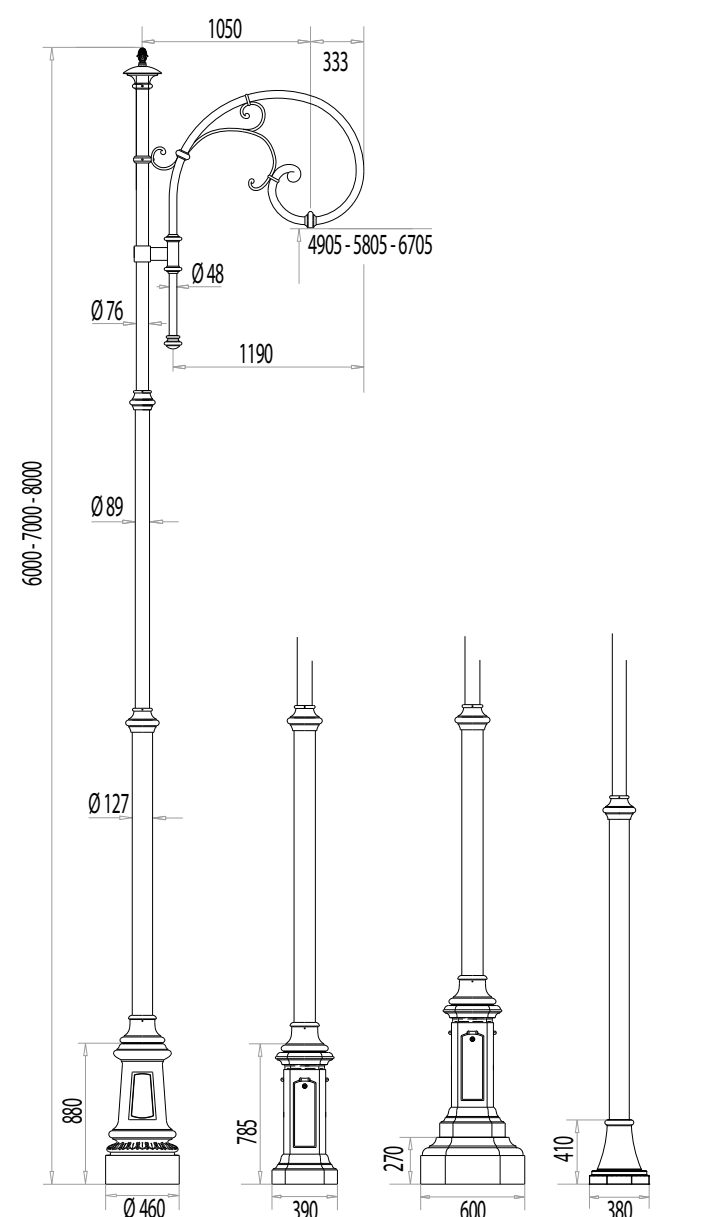

□	LT P1 BC6 H mm 6000 - KG 213	LT P1 B06 H mm 6000 - KG 204	LT P1 BT6 H mm 6000 - KG 258	LT P1 R06 H mm 6000 - KG 144
□	LT P1 BC7 H mm 7000 - KG 222	LT P1 B07 H mm 7000 - KG 213	LT P1 BT7 H mm 7000 - KG 267	LT P1 R07 H mm 7000 - KG 153
□	LT P1 BC8 H mm 8000 - KG 231	LT P1 B08 H mm 8000 - KG 222	LT P1 BT8 H mm 8000 - KG 276	LT P1 R08 H mm 8000 - KG 162
□	LT P2 BC6 H mm 6000 - KG 243	LT P2 B06 H mm 6000 - KG 234	LT P2 BT6 H mm 6000 - KG 288	LT P2 R06 H mm 6000 - KG 174
□	LT P2 BC7 H mm 7000 - KG 252	LT P2 B07 H mm 7000 - KG 243	LT P2 BT7 H mm 7000 - KG 297	LT P2 R07 H mm 7000 - KG 183
□	LT P2 BC8 H mm 8000 - KG 261	LT P2 B08 H mm 8000 - KG 252	LT P2 BT8 H mm 8000 - KG 306	LT P2 R08 H mm 8000 - KG 192
□	LT P3 BC6 H mm 6000 - KG 275	LT P3 B06 H mm 6000 - KG 266	LT P3 BT6 H mm 6000 - KG 320	LT P3 R06 H mm 6000 - KG 206
□	LT P3 BC7 H mm 7000 - KG 284	LT P3 B07 H mm 7000 - KG 275	LT P3 BT7 H mm 7000 - KG 329	LT P3 R07 H mm 7000 - KG 215
□	LT P3 BC8 H mm 8000 - KG 293	LT P3 B08 H mm 8000 - KG 284	LT P3 BT8 H mm 8000 - KG 338	LT P3 R08 H mm 8000 - KG 224

Modelli depositati | Registered design - Scala | Scale 1:40

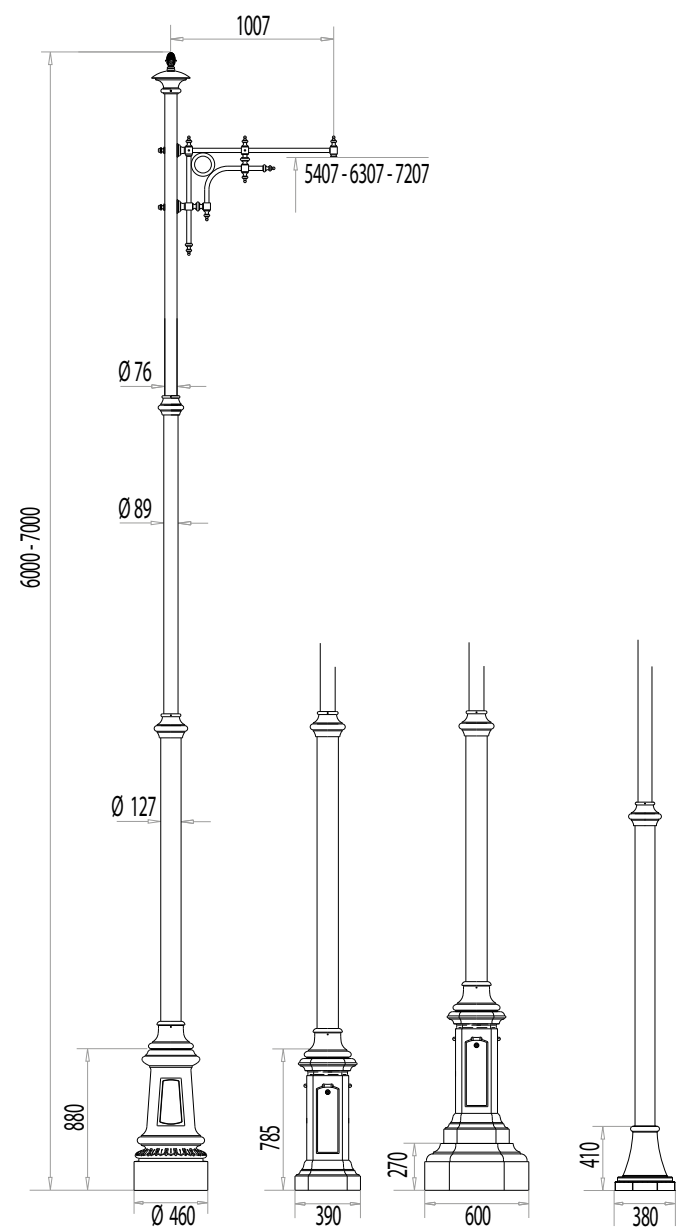

□	LT L1 BC6 H mm 6000 - KG 203	LT L1 B06 H mm 6000 - KG 194	LT L1 BT6 H mm 6000 - KG 248	LT L1 R06 H mm 6000 - KG 134
□	LT L1 BC7 H mm 7000 - KG 212	LT L1 B07 H mm 7000 - KG 203	LT L1 BT7 H mm 7000 - KG 257	LT L1 R07 H mm 7000 - KG 143

Modelli depositati | Registered design - Scala | Scale 1:40

APPLICAZIONI SU PALO APPLICATIONS ON POLES

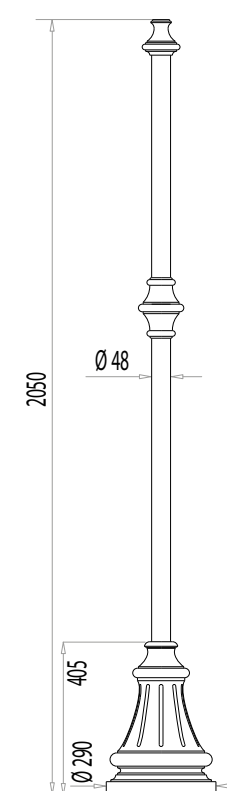
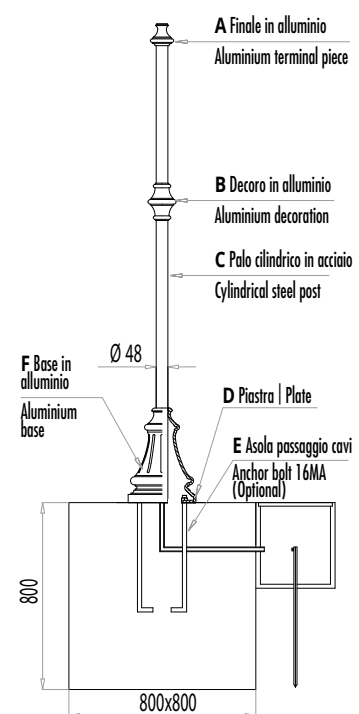

SI 01 BS
 H mm 2050
 KG 22

Modelli depositati | Registered design - Scala | Scale 1:30

APPLICAZIONI SU PALO APPLICATIONS ON POLES

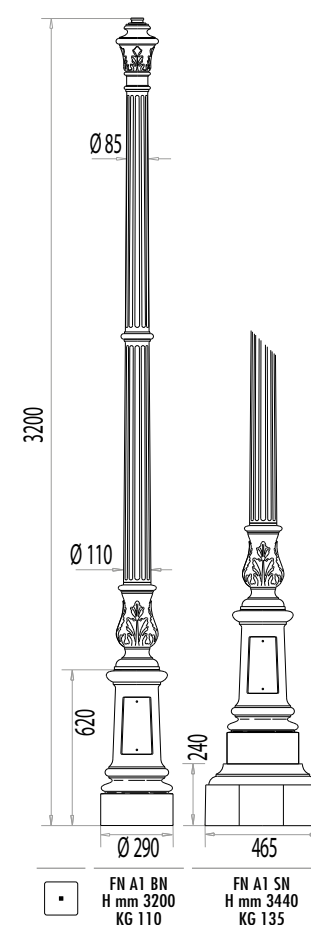
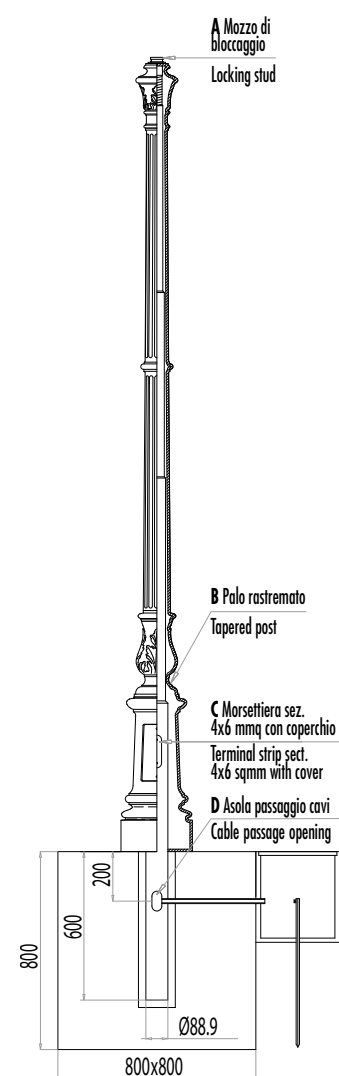

Modelli depositati | Registered design - Scala | Scale 1:30

APPLICAZIONI SU PALO APPLICATIONS ON POLES

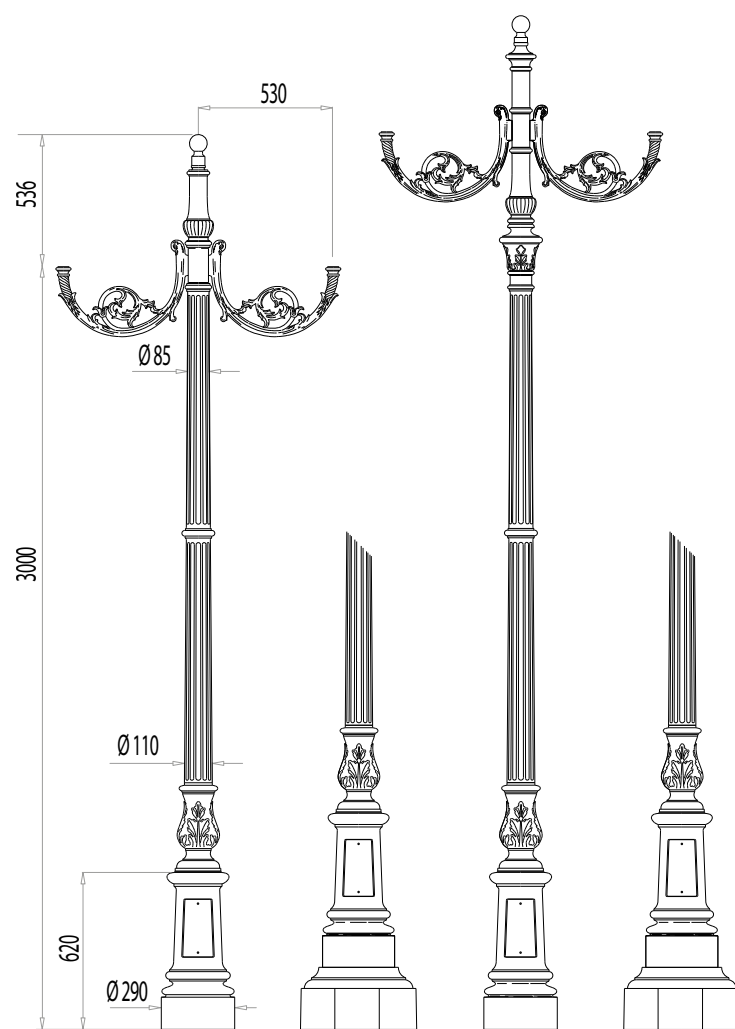

••	FN B2 BN H mm 3000 KG 136	FN B2 SN H mm 3250 KG 161	FN F2 BN H mm 3540 KG 141	FN F2 SN H mm 3790 KG 166
•••	FN B3 BN H mm 3000 KG 144	FN B3 SN H mm 3250 KG 169	FN F3 BN H mm 3540 KG 149	FN F3 SN H mm 3790 KG 174
••••	FN B4 BN H mm 3450 KG 136	FN B4 SN H mm 3700 KG 161	FN F4 BN H mm 3940 KG 141	FN F4 SN H mm 4190 KG 166
•••••	FN B5 BN H mm 3450 KG 144	FN B5 SN H mm 3700 KG 169	FN F5 BN H mm 3940 KG 149	FN F5 SN H mm 4190 KG 174

Modelli depositati | Registered design - Scala | Scale 1:40

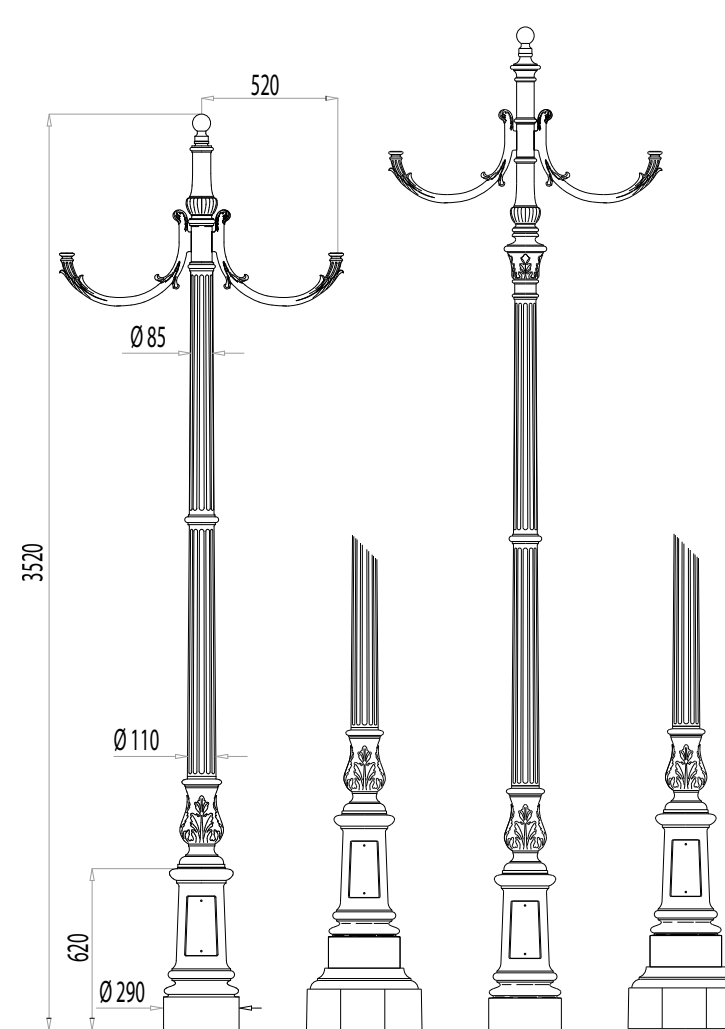

••	FN E2 BN H mm 3450 KG 144	FN E2 SN H mm 3210 KG 159	FN G2 BN H mm 3500 KG 139	FN G2 SN H mm 3750 KG 164
•••	FN E3 BN H mm 2960 KG 141	FN E3 SN H mm 3210 KG 166	FN G3 BN H mm 3500 KG 146	FN G3 SN H mm 3750 KG 171
••••	FN E4 BN H mm 3450 KG 134	FN E4 SN H mm 3700 KG 159	FN G4 BN H mm 3940 KG 139	FN G4 SN H mm 4190 KG 164
•••••	FN E5 BN H mm 3450 KG 141	FN E5 SN H mm 3700 KG 166	FN G5 BN H mm 3940 KG 146	FN G5 SN H mm 4190 KG 171

Modelli depositati | Registered design - Scala | Scale 1:40

APPLICAZIONI SU PALO APPLICATIONS ON POLES

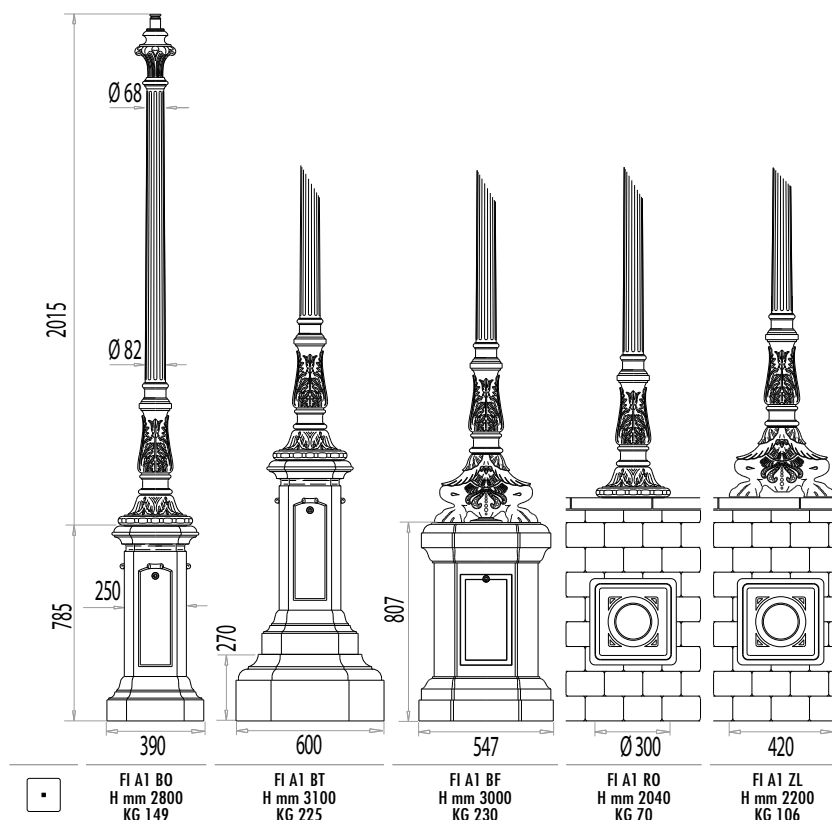
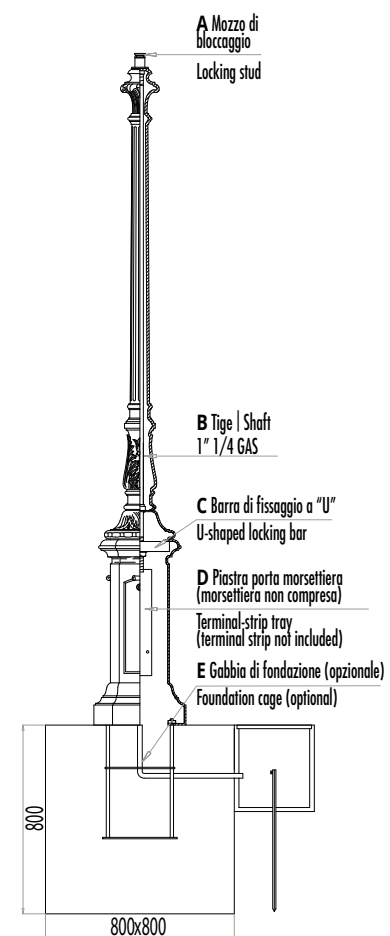

Modelli depositati | Registered design - Scala | Scale 1:30

APPLICAZIONI SU PALO APPLICATIONS ON POLES

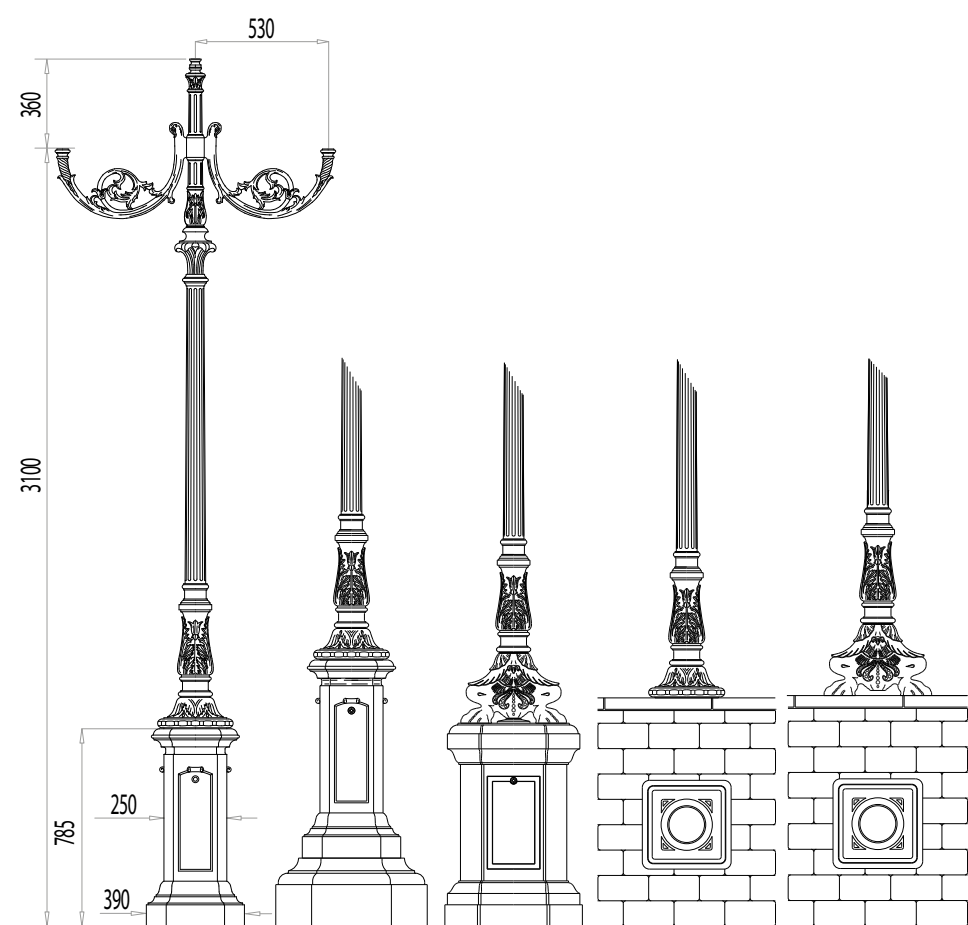

	FI B2 BO H mm 3100 - KG 170	FI B2 BT H mm 3400 - KG 245	FI B2 BF H mm 3300 - KG 250	FI B2 RO H mm 2340 - KG 90	FI B2 ZL H mm 2500 - KG 128
	FI B3 BO H mm 3100 - KG 177	FI B3 BT H mm 3400 - KG 252	FI B3 BF H mm 3300 - KG 257	FI B3 RO H mm 2340 - KG 97	FI B3 ZL H mm 2500 - KG 135
	FI B4 BO H mm 3450 - KG 170	FI B4 BT H mm 3750 - KG 245	FI B4 BF H mm 3650 - KG 250	FI B4 RO H mm 2690 - KG 90	FI B4 ZL H mm 2850 - KG 128
	FI B5 BO H mm 3450 - KG 177	FI B5 BT H mm 3750 - KG 252	FI B5 BF H mm 3650 - KG 257	FI B5 RO H mm 2690 - KG 97	FI B5 ZL H mm 2850 - KG 135

Modelli depositati | Registered design - Scala | Scale 1:30

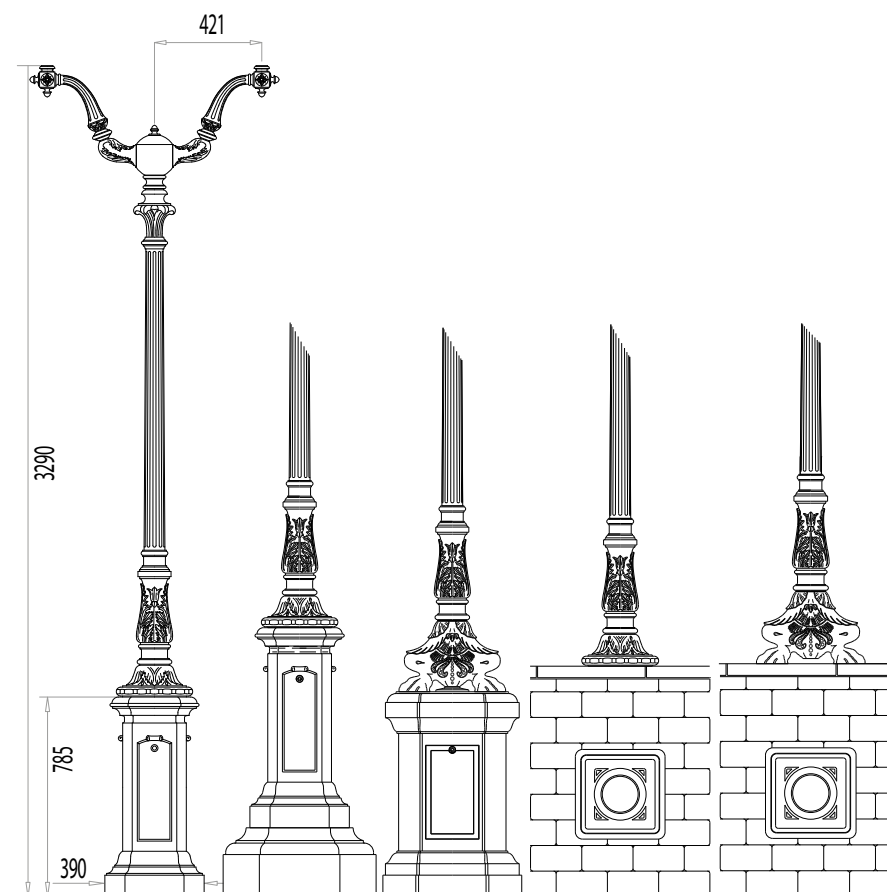

	FI C2 BO H mm 3290 - KG 178	FI C2 BT H mm 3590 - KG 254	FI C2 BF H mm 3490 - KG 257	FI C2 RO H mm 2530 - KG 97	FI C2 ZL H mm 2690 - KG 136
	FI C3 BO H mm 3290 - KG 189	FI C3 BT H mm 3590 - KG 265	FI C3 BF H mm 3490 - KG 268	FI C3 RO H mm 2530 - KG 108	FI C3 ZL H mm 2690 - KG 147
	FI C4 BO H mm 3585 - KG 187	FI C4 BT H mm 3885 - KG 263	FI C4 BF H mm 3785 - KG 263	FI C4 RO H mm 2825 - KG 108	FI C4 ZL H mm 2985 - KG 145
	FI C5 BO H mm 3585 - KG 198	FI C5 BT H mm 3885 - KG 274	FI C5 BF H mm 3785 - KG 278	FI C5 RO H mm 2825 - KG 119	FI C5 ZL H mm 2985 - KG 156

Modelli depositati | Registered design - Scala | Scale 1:30

APPLICAZIONI SU PALO APPLICATIONS ON POLES

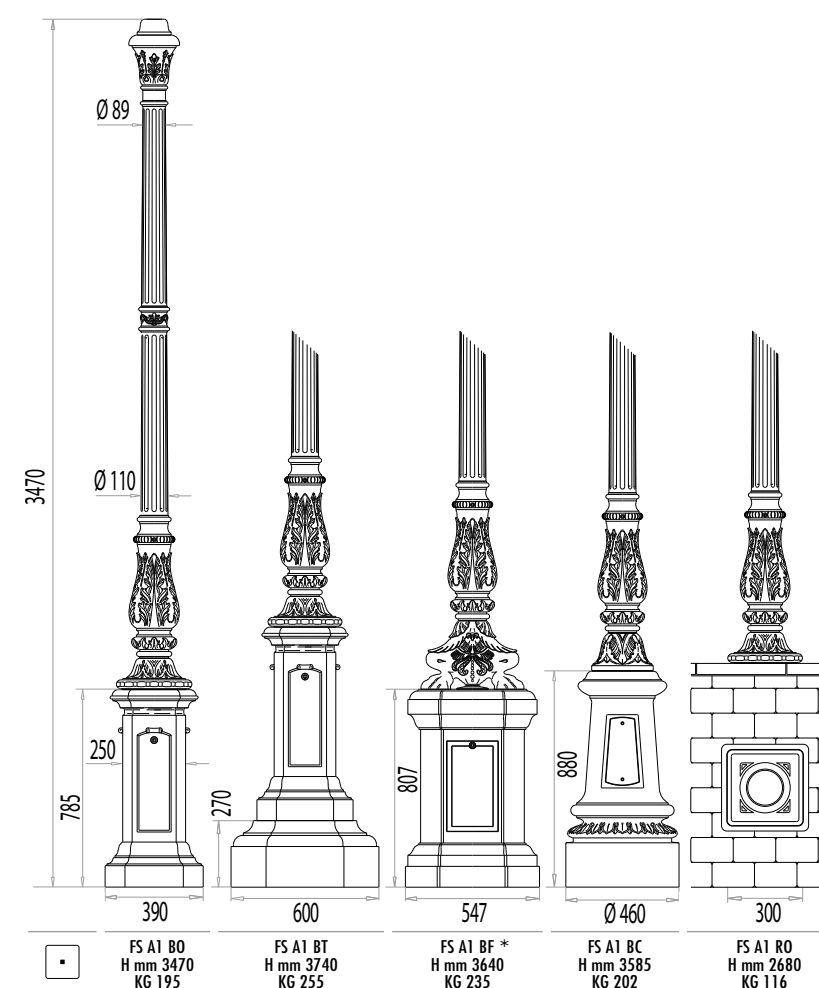
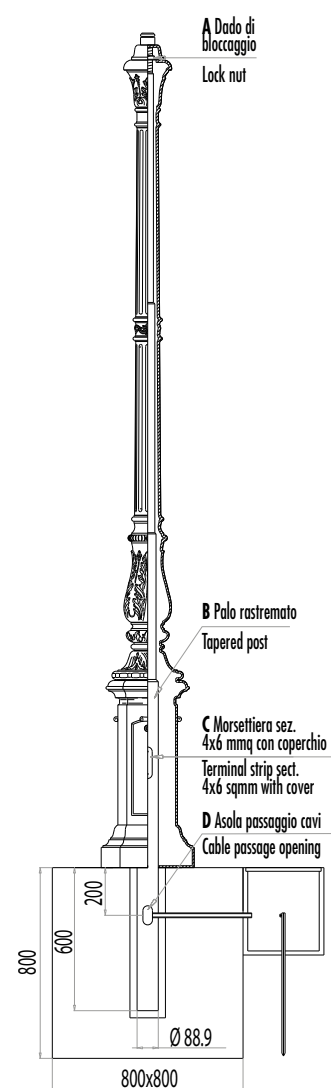

Modelli depositati | Registered design - Scala | Scale 1:30

APPLICAZIONI SU PALO APPLICATIONS ON POLES

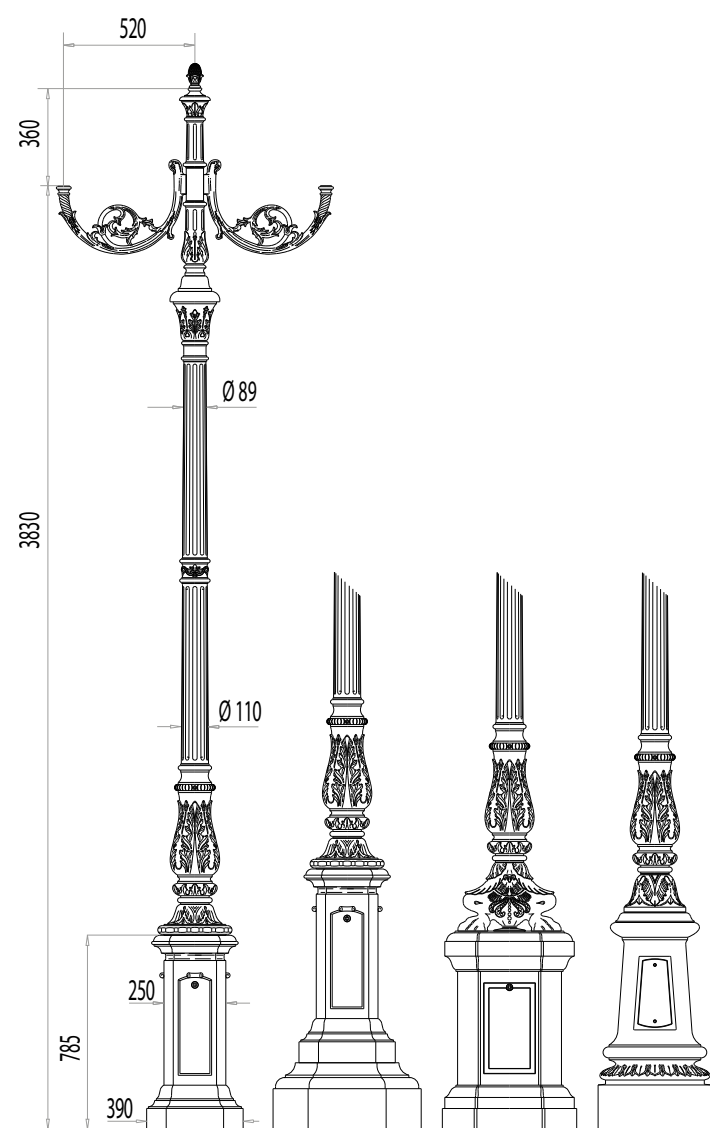

••	FS B2 BO H mm 3830 - KG 230	FS B2 BT H mm 4100 - KG 290	FS B2 BF* H mm 4000 - KG 270	FS B2 BC H mm 3945 - KG 237
•••	FS B3 BO H mm 3830 - KG 237	FS B3 BT H mm 4100 - KG 297	FS B3 BF H mm 4000 - KG 277	FS B3 BC H mm 3945 - KG 244
••••	FS B4 BO H mm 4220 - KG 230	FS B4 BT H mm 4490 - KG 290	FS B4 BF H mm 4390 - KG 270	FS B4 BC H mm 4335 - KG 237
•••••	FS B5 BO H mm 4220 - KG 237	FS B5 BT H mm 4490 - KG 297	FS B5 BF - H mm 4390 - KG 277	FS B5 BC H mm 4335 - KG 244

Modelli depositati | Registered design - Scala | Scale 1:30

Il disegno sopra si riferisce al sistema di montaggio per candelabri nelle versioni BO - BT - BC
*per base BF: kit di tirafondi fornito separatamente.
The drawing above refers to the mounting system for candelabra in BO - BT - BC versions.
* bf base: a kit of anchor bolts is separately supplied

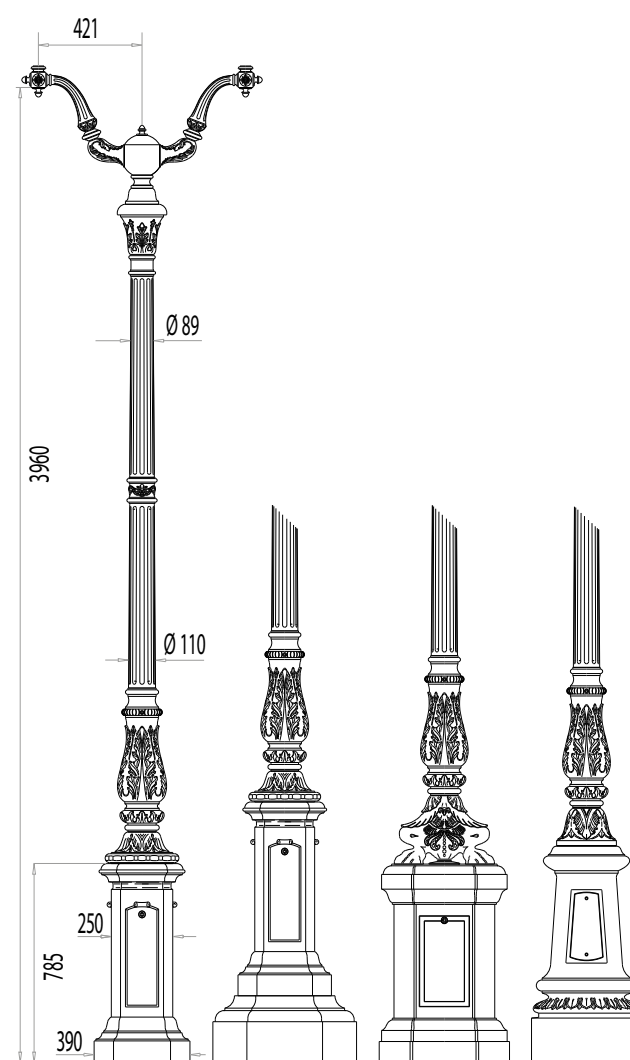

••	FS C2 BO H mm 3960 - KG 225	FS C2 BT H mm 4230 - KG 285	FS C2 BF* H mm 4130 - KG 275	FS C2 BC H mm 4075 - KG 232
•••	FS C3 BO H mm 3960 - KG 236	FS C3 BT H mm 4230 - KG 296	FS C3 BF H mm 4130 - KG 286	FS C3 BC H mm 4075 - KG 243
••••	FS C4 BO H mm 4310 - KG 230	FS C4 BT H mm 4580 - KG 290	FS C4 BF H mm 4480 - KG 270	FS C4 BC H mm 4425 - KG 237
•••••	FS C5 BO H mm 4310 - KG 241	FS C5 BT H mm 4580 - KG 301	FS C5 BF H mm 4480 - KG 281	FS C5 BC H mm 4425 - KG 248

Modelli depositati | Registered design - Scala | Scale 1:30

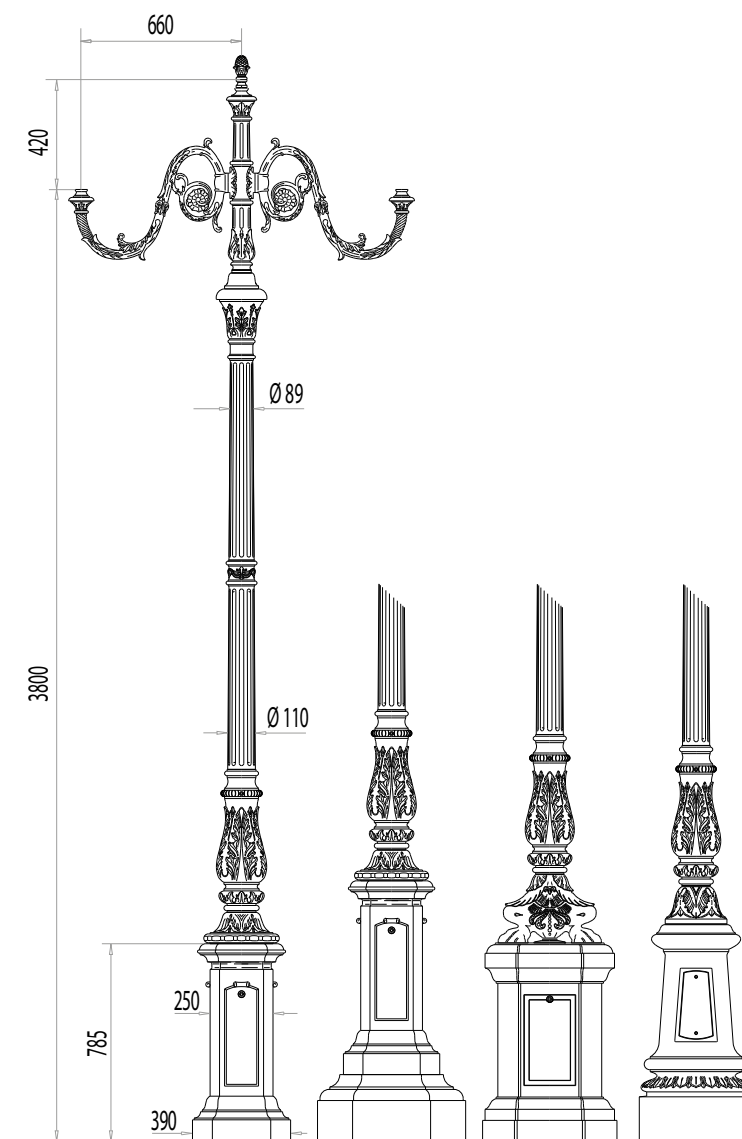

••	FS D2 BO H mm 3800 - KG 240	FS D2 BT H mm 4070 - KG 300	FS D2 BF* H mm 3970 - KG 280	FS D2 BC H mm 3915 - KG 247
•••	FS D3 BO H mm 3800 - KG 254	FS D3 BT H mm 4070 - KG 314	FS D3 BF H mm 3970 - KG 294	FS D3 BC H mm 3915 - KG 261
••••	FS D4 BO H mm 4220 - KG 240	FS D4 BT H mm 4490 - KG 300	FS D4 BF H mm 4390 - KG 280	FS D4 BC H mm 4335 - KG 247
•••••	FS D5 BO H mm 4220 - KG 254	FS D5 BT H mm 4490 - KG 314	FS D5 BF H mm 4390 - KG 294	FS D5 BC H mm 4335 - KG 261

Modelli depositati | Registered design - Scala | Scale 1:30

APPLICAZIONI SU PALO APPLICATIONS ON POLES

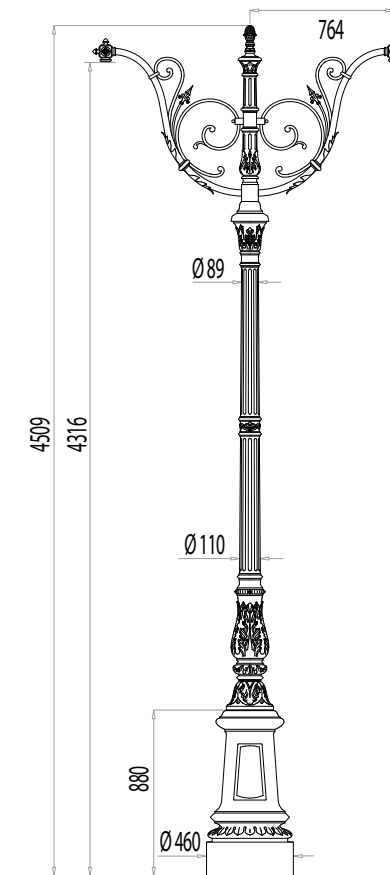
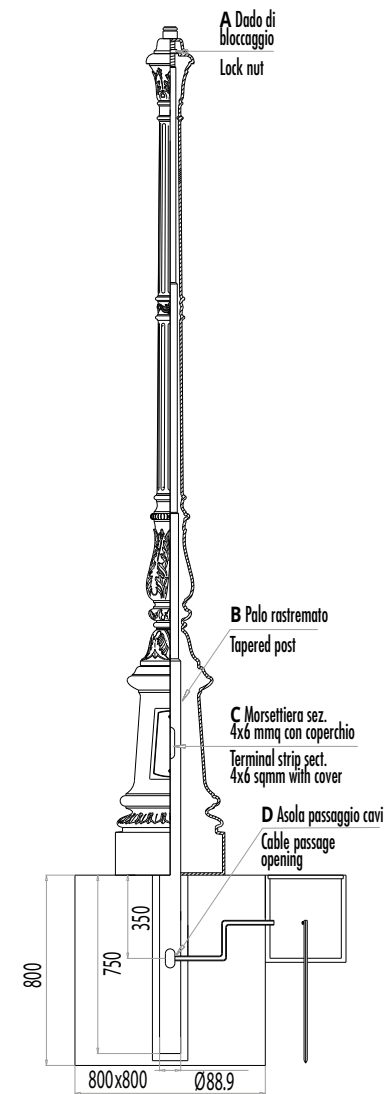

FS H2 BC H mm 4330 - KG 238	FS H3 BC H mm 4330 - KG 248	FS H4 BC H mm 4380 - KG 238	FS H5 BC H mm 4380 - KG 248

Modelli depositati | Registered design - Scala | Scale 1:40

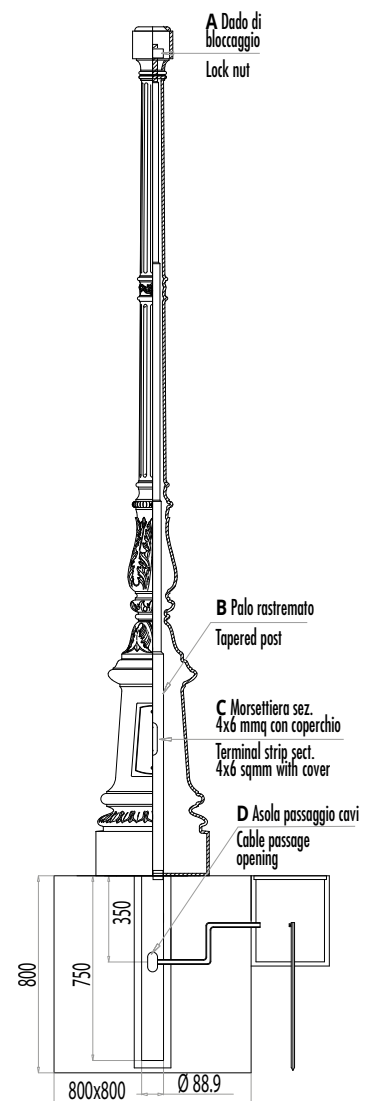

APPLICAZIONI SU PALO APPLICATIONS ON POLES

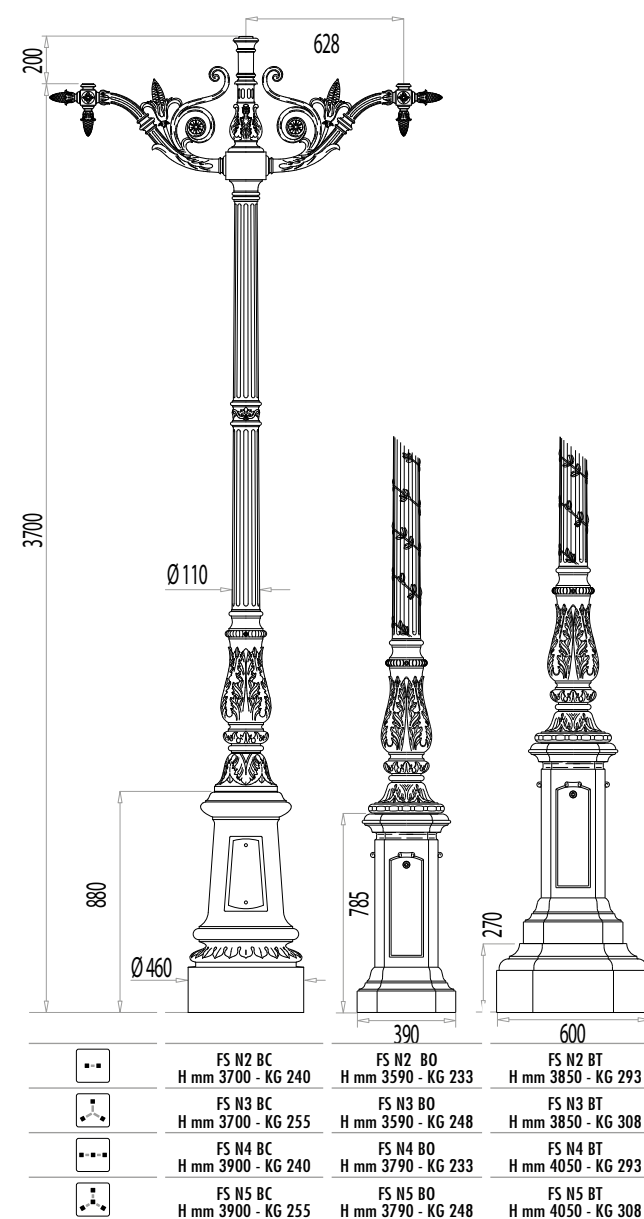

Modelli depositati | Registered design - Scala | Scale 1:30

APPLICAZIONI SU PALO APPLICATIONS ON POLES

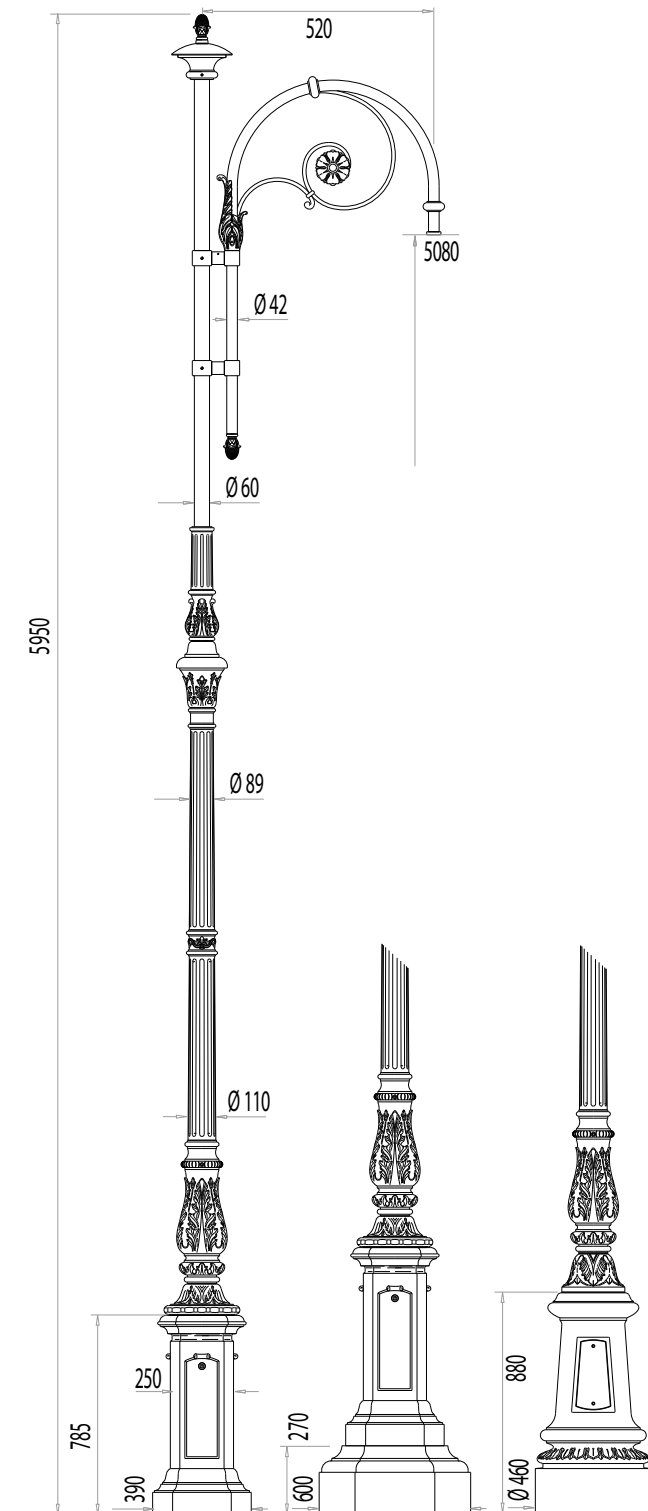
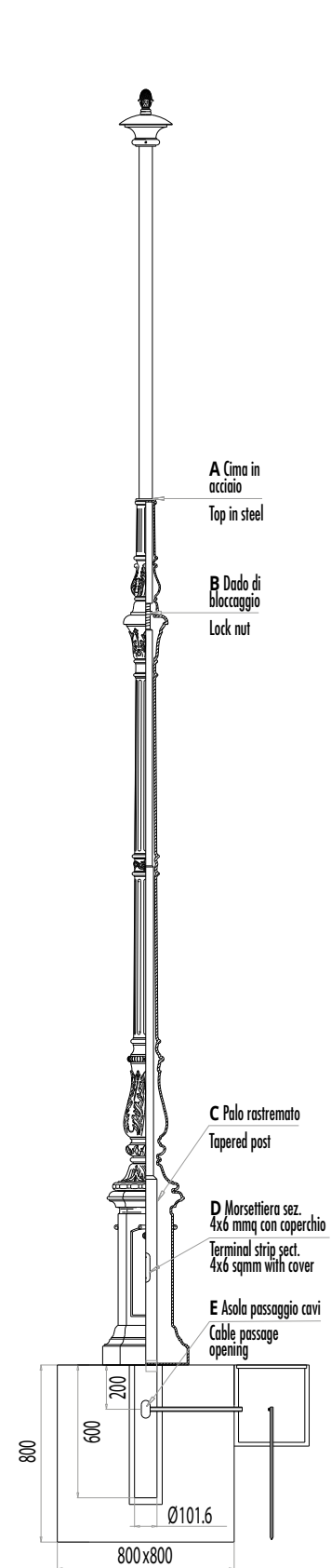

•	FG M1 BO H mm 5950 - KG 220	FG M1 BT H mm 6220 - KG 280	FG M1 BC H mm 6065 - KG 227
••	FG M2 BO H mm 5950 - KG 235	FG M2 BT H mm 6220 - KG 295	FG M2 BC H mm 6065 - KG 242
•••	FG M3 BO H mm 5950 - KG 249	FG M3 BT H mm 6220 - KG 309	FG M3 BC H mm 6065 - KG 256

Modelli depositati | Registered design - Scala | Scale 1:30

GRANDUCATO

BRACCI | BRACKETS

Le strade, i borghi, i vicoli dei centri storici nascondono spesso palazzi di inestimabile valore artistico o piccole meraviglie dell'arte. I BRACCI AEC, installati sulle facciate, creano un'atmosfera capace di suscitare antiche suggestioni e amore per la storia della città.

AEC LIGHTING BRACKETS respect at full the architectural tradition of our historic city centers which often conceal roads, squares and buildings of inestimable artistic value.



APPLICAZIONI SU BRACCI

APPLICATIONS ON BRACKETS

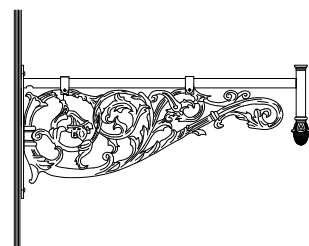

BR 01
Sporgenza / Projection
mm 1000
KG 18,5

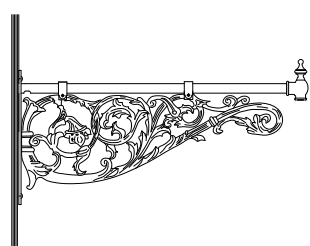

BR 02 R
Sporgenza / Projection
mm 1000
KG 18,5

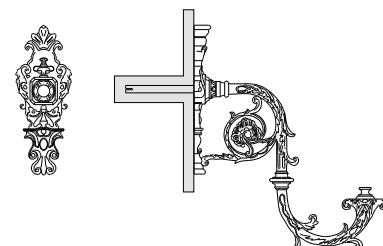

BR 09
Sporgenza / Projection
mm 700
KG 24

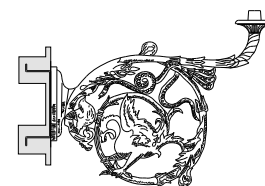

BR 10
Sporgenza / Projection
mm 750
KG 34

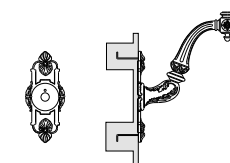

BR 11
Sporgenza / Projection
mm 380
KG 15

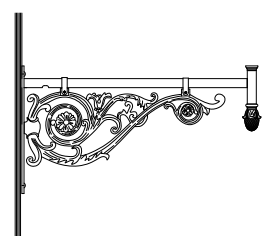

BR 03
Sporgenza / Projection
mm 850
KG 13

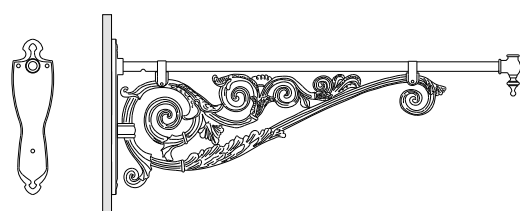

BR 04
Sporgenza / Projection
mm 1400
KG 32

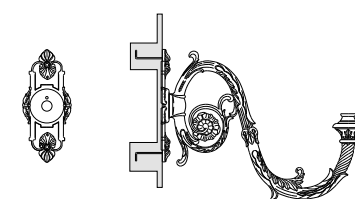

BR 12
Sporgenza / Projection
mm 700
KG 18

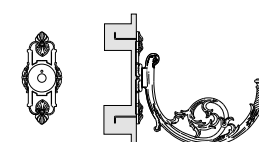

BR 13
Sporgenza / Projection
mm 500
KG 13

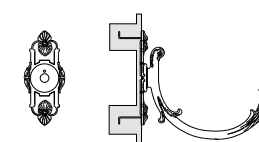

BR 14
Sporgenza / Projection
mm 500
KG 10

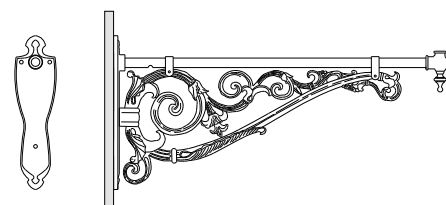

BR 05
Sporgenza / Projection
mm 1150
KG 25

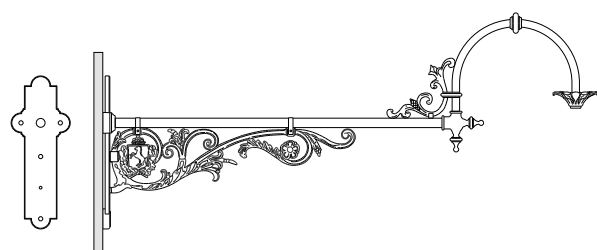

BR 06
Sporgenza / Projection
mm 1630
KG 24

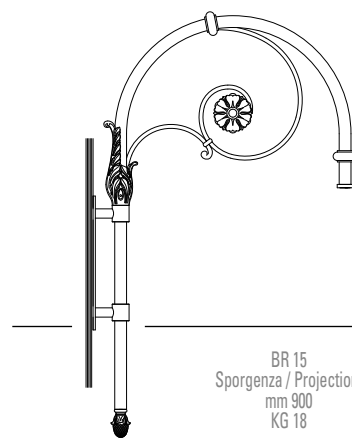

BR 15
Sporgenza / Projection
mm 900
KG 18

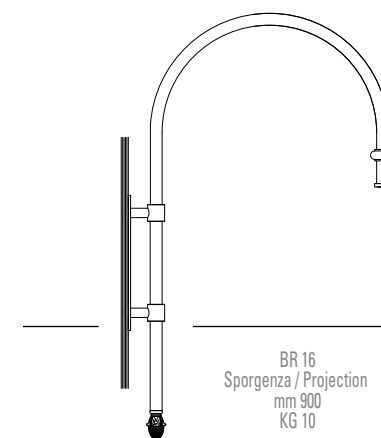

BR 16
Sporgenza / Projection
mm 900
KG 10

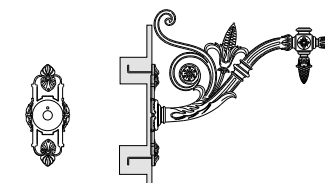

BR 18
Sporgenza / Projection
mm 580
KG 20

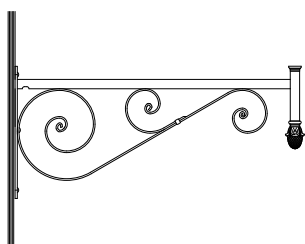

BR 07
Sporgenza / Projection
mm 1000
KG 11

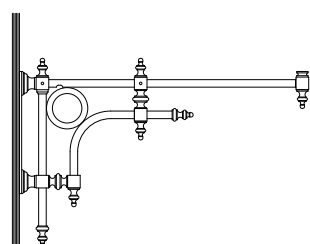

BR 08
Sporgenza / Projection
mm 1000
KG 17

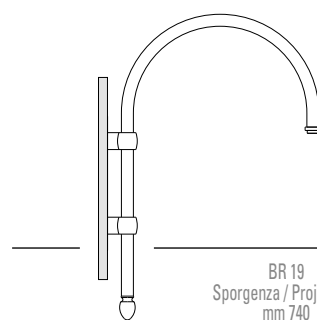

BR 19
Sporgenza / Projection
mm 740
KG 9

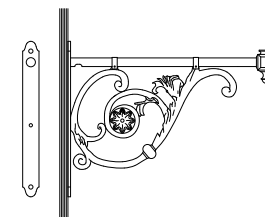

BR 50
Sporgenza / Projection
mm 600
KG 11,5

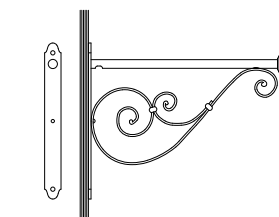

BR 51
Sporgenza / Projection
mm 600
KG 5

LANTERNE | LANTERNS

La serie di lanterne AEC è espressione di amore per la tradizione e rispetto per ambientazioni di grande valore storico e artistico. Forme eleganti e decorazioni raffinate conferiscono stile all'illuminazione e mettono in luce la bellezza degli scenari di contorno.

AEC lanterns represent the maximum expression of love and respect for the tradition of great historical city centers. Elegant shapes and refined decoration contribute to enhance lighting revealing the beauty of the surroundings.



1



2

1. Firenze (Italy)
2. Grottammare (Italy)
3. Kragerø (Norway)



3

FIRENZE

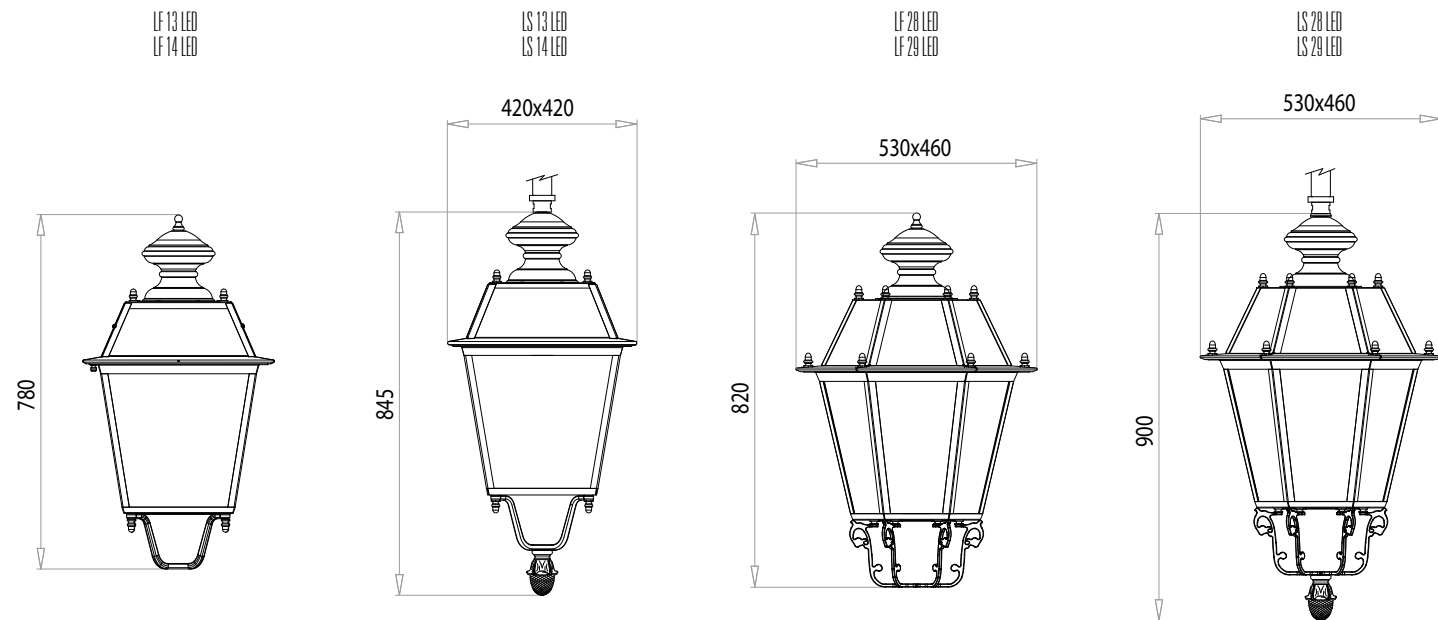

VERSIONI DISPONIBILI | AVAILABLE VERSIONS
ACCIAIO E OTTONE - STEEL AND BRASS



1



2

- 1. Firenze (Italy)
- 2. Grottammare (Italy)
- 3. Kragerø (Norway)



LF 13 CUT-OFF

LF 28

VERSIONI DISPONIBILI | AVAILABLE VERSIONS
ACCIAIO E OTTONE - STEEL AND BRASS



SI 08



SI 06



SI 07

VERSIONI DISPONIBILI | AVAILABLE VERSIONS

ACCIAIO E OTTONE - STEEL AND BRASS

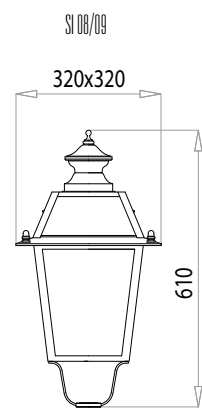

SI 08/09

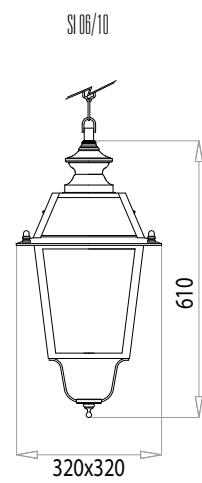

SI 06/10

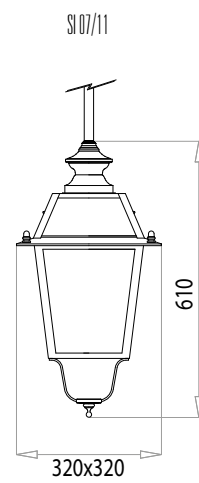

SI 07/11



FIRENZE



SC 40



VERSIONI DISPONIBILI | AVAILABLE VERSIONS

ACCIAIO - STEEL

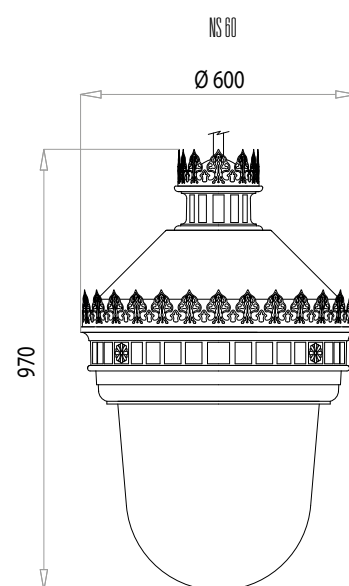
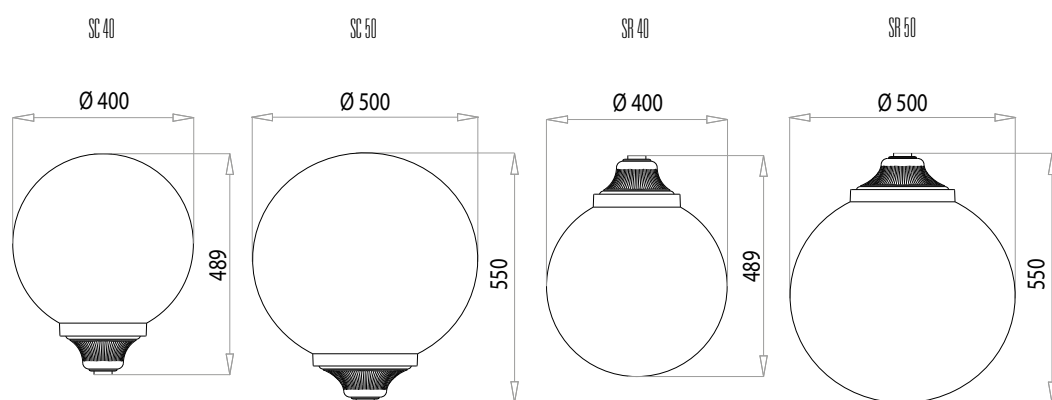

MILANO



MP 40

VERSIONI DISPONIBILI | AVAILABLE VERSIONS

OTTONE - BRASS

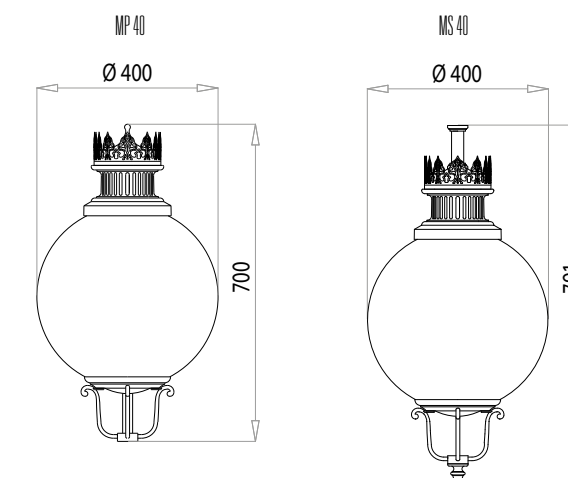



LAMPARA

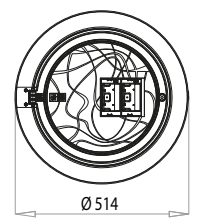
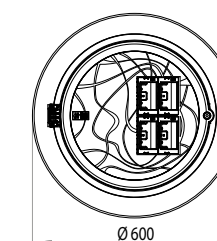
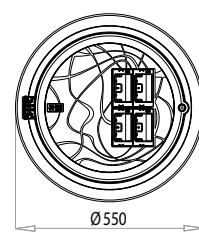
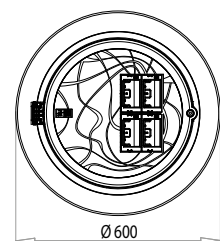
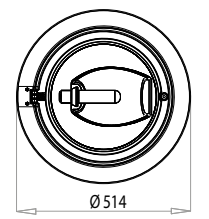
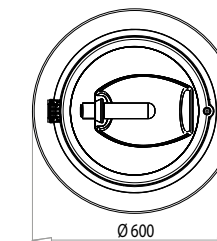
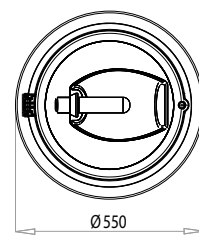
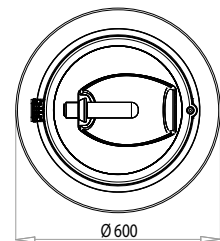
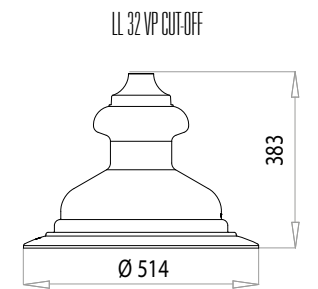
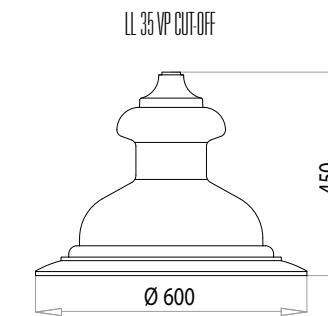
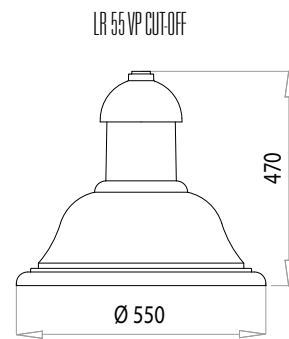
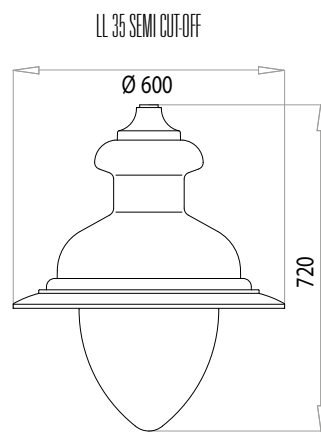





I dati pubblicati in questo catalogo non sono impegnativi.
Al fine di favorire un costante aggiornamento dei propri prodotti,
AEC si riserva il diritto di apportare modifiche senza preavviso.

*The information contained in this catalogue aren't binding.
In order to guarantee a continuous updating of its products,
AEC reserves itself the right to modify the contents without notice.*